

THE ARUP JOURNAL

DECEMBER 1977

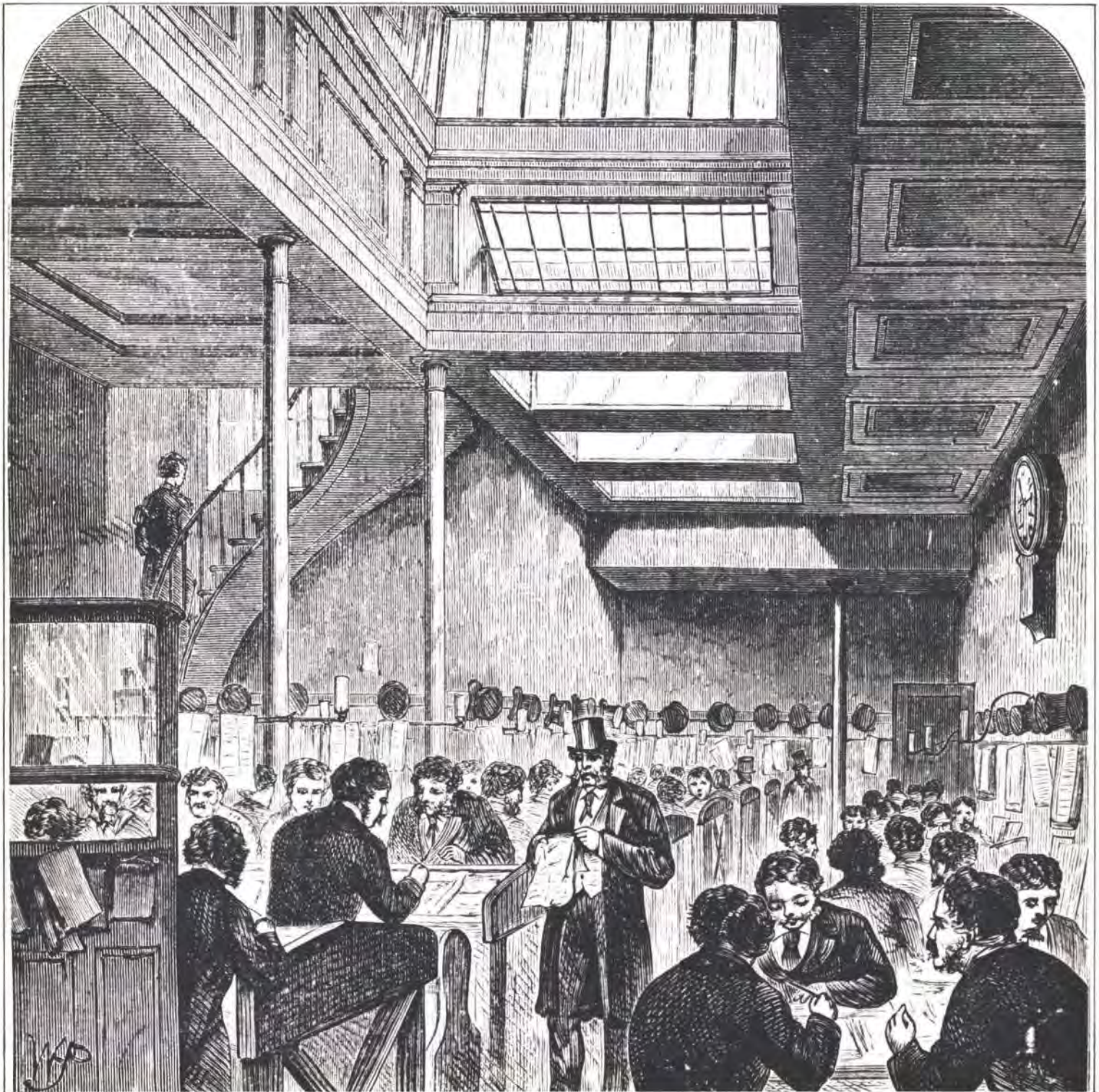

THE ARUP JOURNAL

Vol. 12 No. 4 December 1977
Published by
Ove Arup Partnership
13 Fitzroy Street, London, W1P 6BO

Editor: Peter Hoggett
Art Editor: Desmond Wyeth FSIAD
Assistant Editor: David Brown

Contents

Offices, by Philip Dowson	2
Byker Viaduct, by W. Smyth	24
New head office for the Scottish Widows Fund and Life Assurance Society, Edinburgh, by D. Colley	28
The Tower at Doha, by M. Willford and D. Croft	32
Computer controlled environments, by R. Aish	37
Structural Steel Design Award	39

Front cover: The Clearing House of the Bank of England, 1897 (Photo: copyright Radio Times Hulton Picture Library)
Back cover: Byker Viaduct: precast unit (Photo: Robert Benaim)

Offices

Philip Dowson

I want to explore some ideas.

The modern 'office block', in conjunction with the urban motorway, has become a prime symbol of today's 'built vandalism', masquerading in the clothes of the 'built environment'. The 'unacceptable face' of architecture, lending its name to commercial exploitation. The visible and outward expression of the inner logic of what one client called 'the maximization of space utilization', reflecting the attitudes of the Counting House rather than a Culture; indifferent to the real purpose which should be to provide a good place for people to work in. There is, however, no intrinsic reason for the 'office block' to carry the burden of this symbolism, nor indeed has it done so until recently. Some of the finest examples of architecture during the last 100 years or so, including the present, have been office buildings.

Offices as communities

I want to explore some ideas in this article because I believe that attitudes towards their design are changing fairly radically. Indeed, to ask the question 'How to retain the scale and simple humanity in large, highly sophisticated building complexes?' can produce rather unconventional answers. However, an answer to that question is necessary if these buildings are to contribute to people's physical well-being as they should do, and recognize the individual's need for identity within them. Working communities are diverse, and varied, and the buildings that clothe them should reflect the character of these differences, and so their uniqueness. The designs should ensure that they are not ironed out and obliterated by considerations of adaptability, flexibility, maximum net usable area, or whatever

else, if they are to have a human reference. I have used the analogy before of a new material which will often inherit the forms of an older one until it is better understood, and a new design grammar applicable to the new material is developed. So the form of heavily serviced buildings, including offices, with closely controlled environments, will take time to be better reflected in their designs. This is particularly the case now with the pressure to conserve energy.

Adaptability

I have also in the past referred to the classic, wide Utopian office interiors – the endless, perfectly lit, air-conditioned nightmares – spacelessness – and the clinical perfection of detail which aims at solving technical problems rather than providing a more interesting and human place for people to work in. The danger of the anonymity that goes hand in hand with adaptability has been recognized and emphasized as a problem for a long time. Where the accepted priority for adaptability does not recognize the need for individual, as well as corporate identity, or of expression, the designs will create their own particular kind of tyranny.

Yet adaptable designs, even when they do take into account social and human aspects and avoid this pitfall, too readily get abused. Perhaps, therefore, the more *positive* and *demanding* of attention a building is, the better. A 'passive' solution, which can be ill-used easily, will be ill-used. However neat and ingenious the flexible 'clip-up' partitions, suspended ceilings, etc., may be, interiors will degenerate almost inevitably into the 'aseptic slums' that one has come to associate with rich international bodies. Imaginative management can of course resist this tendency, but the buildings themselves must also help. If the designs are strong and positive enough to resist, or to some extent suppress, the consequences of unimaginative management, then the buildings are more likely to retain

their presence and character. Working a building up as a new ship is worked up, and running it creatively, remain low on priority lists and all too visibly so. Bürolandschaft 'open office' remains also an open invitation to expanding firms to abuse its provision and mutilate the ideas behind it by overcrowding. Understandably, Bürolandschaft now has a bad name.

What is necessary is an adaptability which can provide for change, but in a way which leaves the result looking at any one time uniquely solved: that provides interiors that are not arbitrary, but that at any one time should appear completed. A search for the architectural Golden Fleece? – perhaps.

Uniqueness and circulation

However, 'big can be beautiful'; witness the great medieval institutions. However, whilst I would not want to take the analogy too far, monasteries are nevertheless marvellous examples of very large complexes, composed of widely differing building types, and which housed large communities.

The 'multi-national corporations' of yesterday. Within them, visibly structured spaces, eloquently expressing their purposes, were linked to a circulation pattern that formed a kind of invisible armature onto which the various parts and functions were attached.

Fig. 1 right
Truman's offices, Brick Lane: focus of circulation and a place common to all



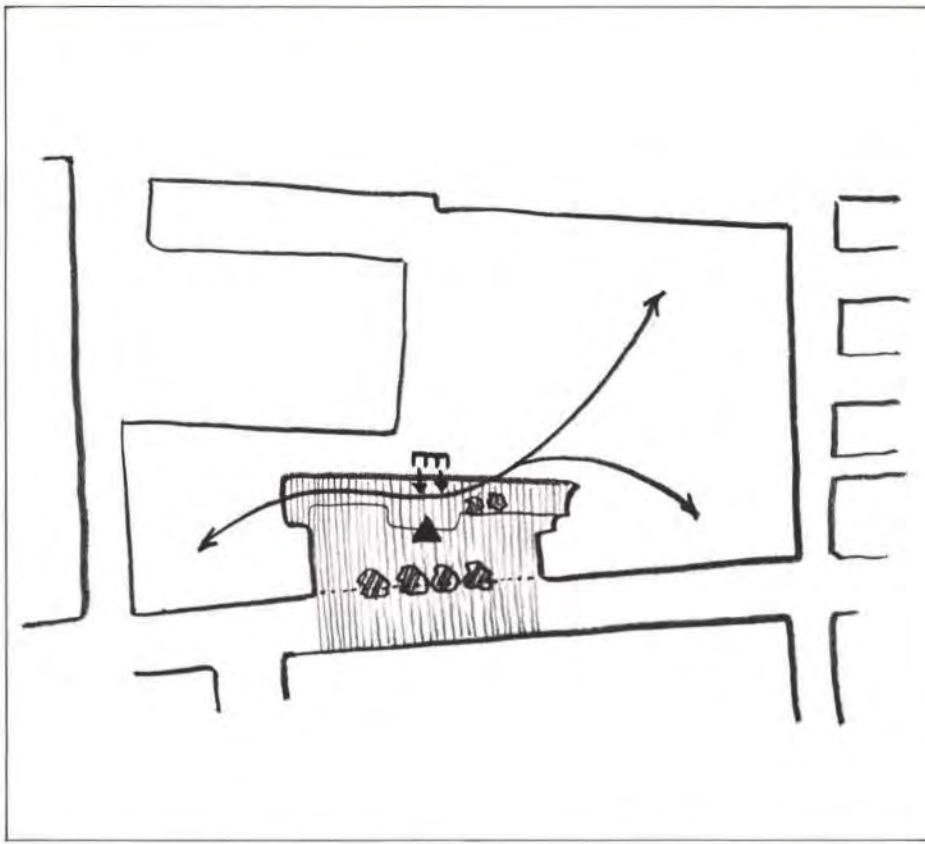

Fig. 2
Truman's offices: Site diagram. A conservatory to which all primary access, lifts, amenity areas, and so on have direct access, joining both sides of the site together

In the design of a large building, the pattern of circulation is fundamental to an understanding of its form and a sense of place within it – the sense of arrival and departure – of moving from one place to another place, which should further help to emphasize the nature of both – the intensity of their use and their mood. I would particularly emphasize the subtlety of this aspect in these large medieval institutions, i.e. nave, aisle, crossing, ambulatory, sanctuary, cloister, cell and so on. These were places in which it was possible to congregate or withdraw, to communicate as well as to reflect. The largest scale and the smallest scale were accommodated within these buildings with a humanity, manifest in their structured form. These were very large buildings, for very large institutions. Yet the elements were complementary and 'big was somehow beautiful'.

So in office communities the design of the circulation should signal the places which are common to all, as well as those places that are private to the few, and it would be difficult to overstate the importance of this aspect. To make the circulation within a building eventful and stimulating will be to vitalize the architecture. It is the shape of this circulation that makes the anatomy of a building understandable to those moving through it, and so prevents the 'part' becoming severed from 'the whole', the small scale from the large scale, and the individual from any sense of belonging.



Fig. 3
Truman's offices. A perimeter corridor links diverse and separate areas in an eventful way

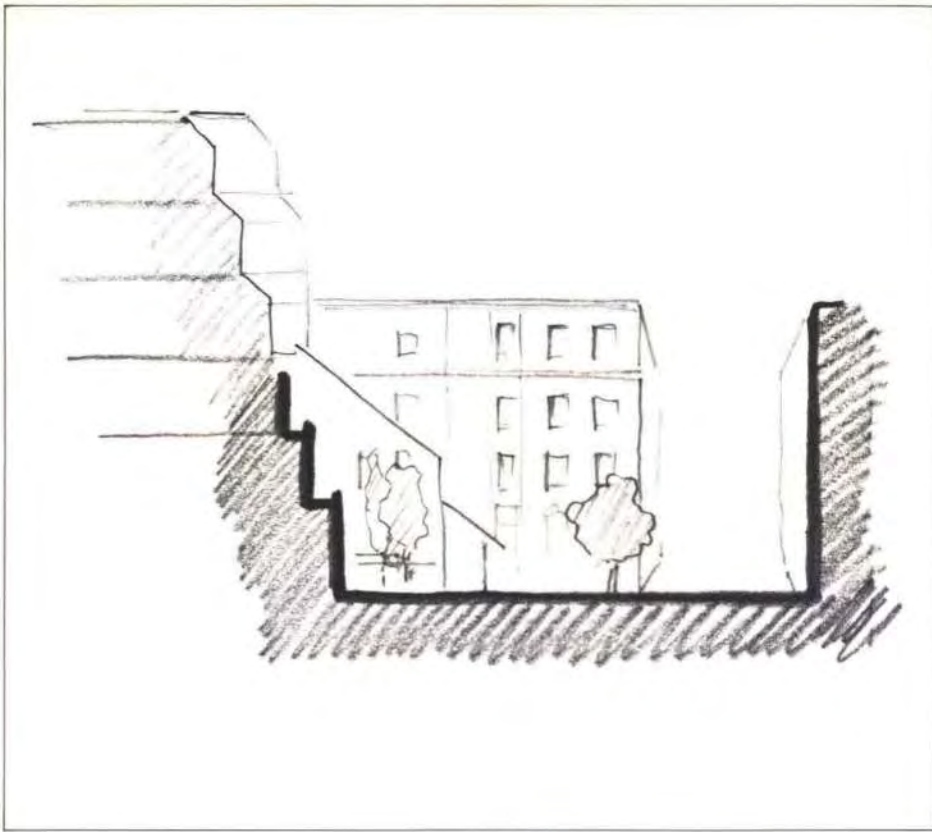

Fig. 4
The conservatory is simply a glazed-in area
of the new square. The focus of the whole
scheme is the new square itself

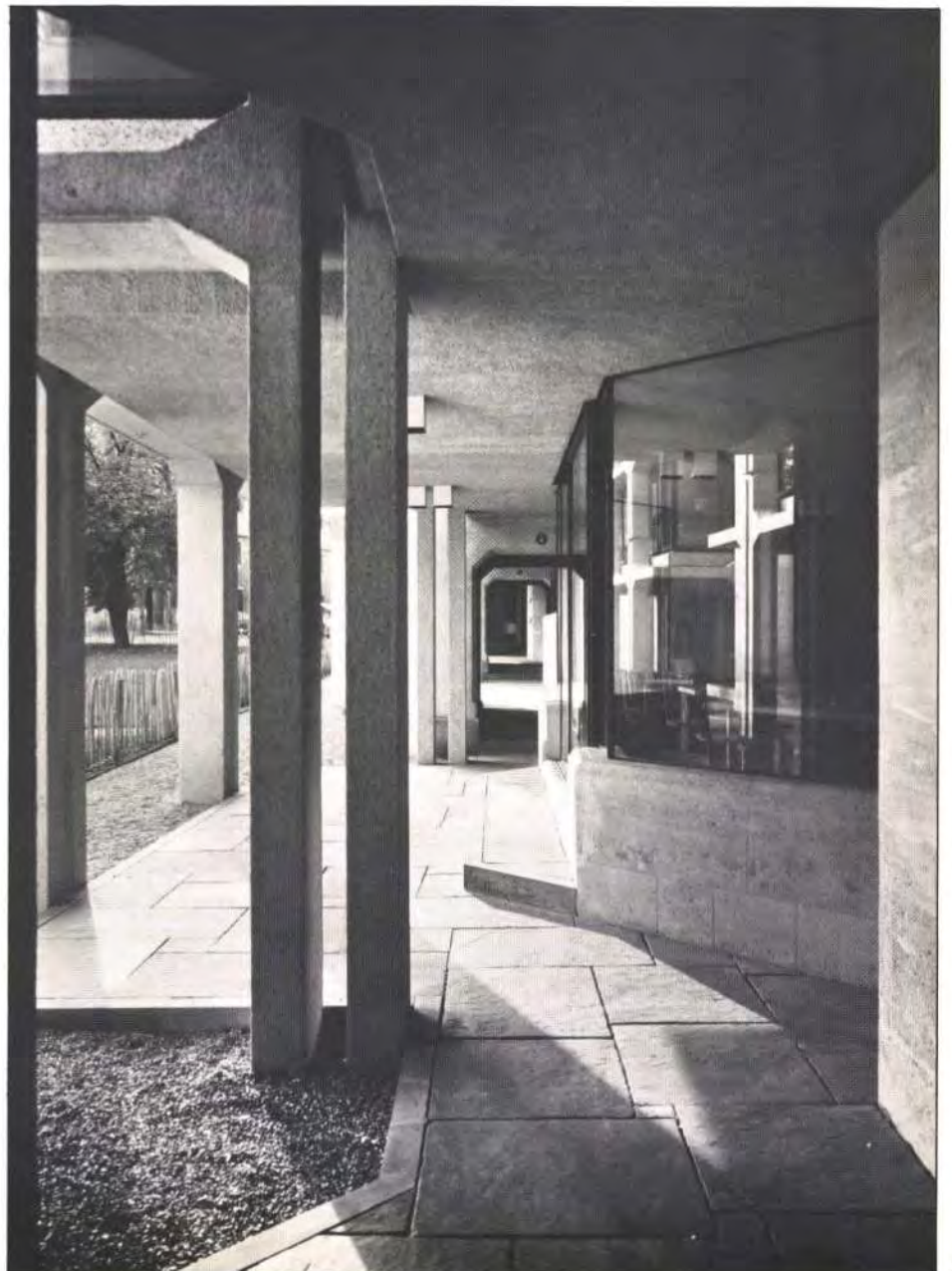

Fig. 5
Progressive circulation

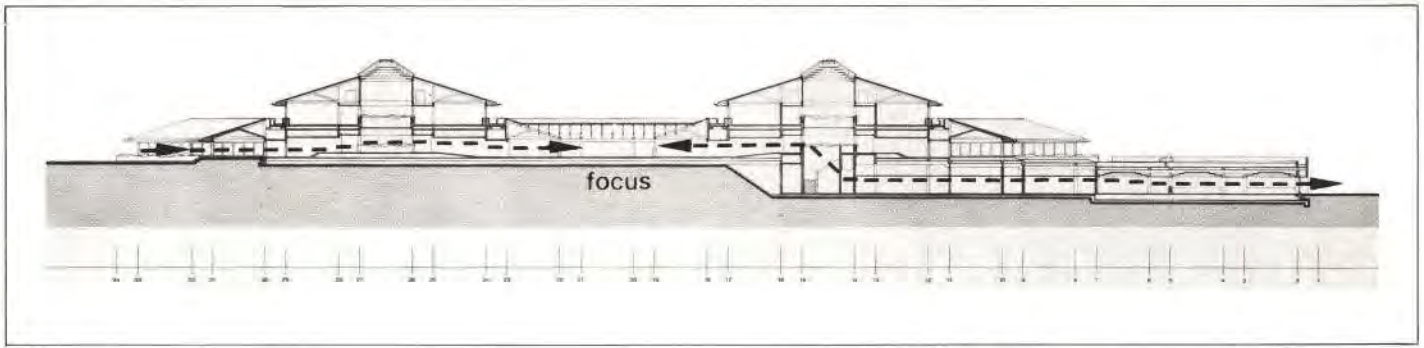

Fig. 6 above
CEGB offices, Bedminster Down: section showing movement pattern

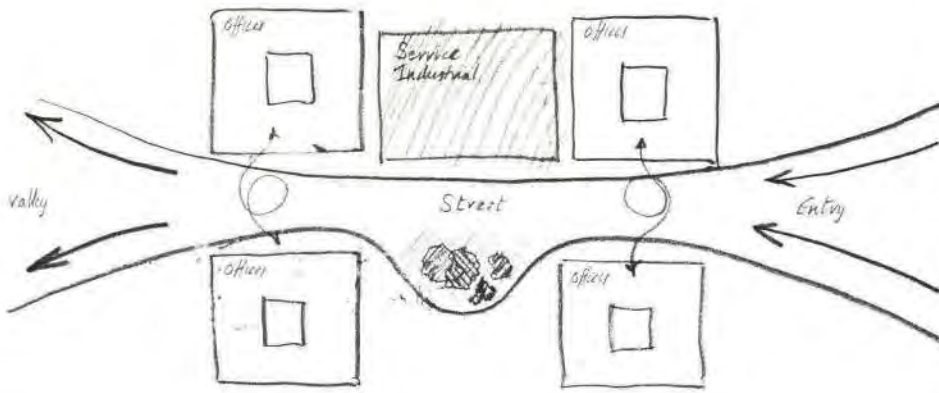
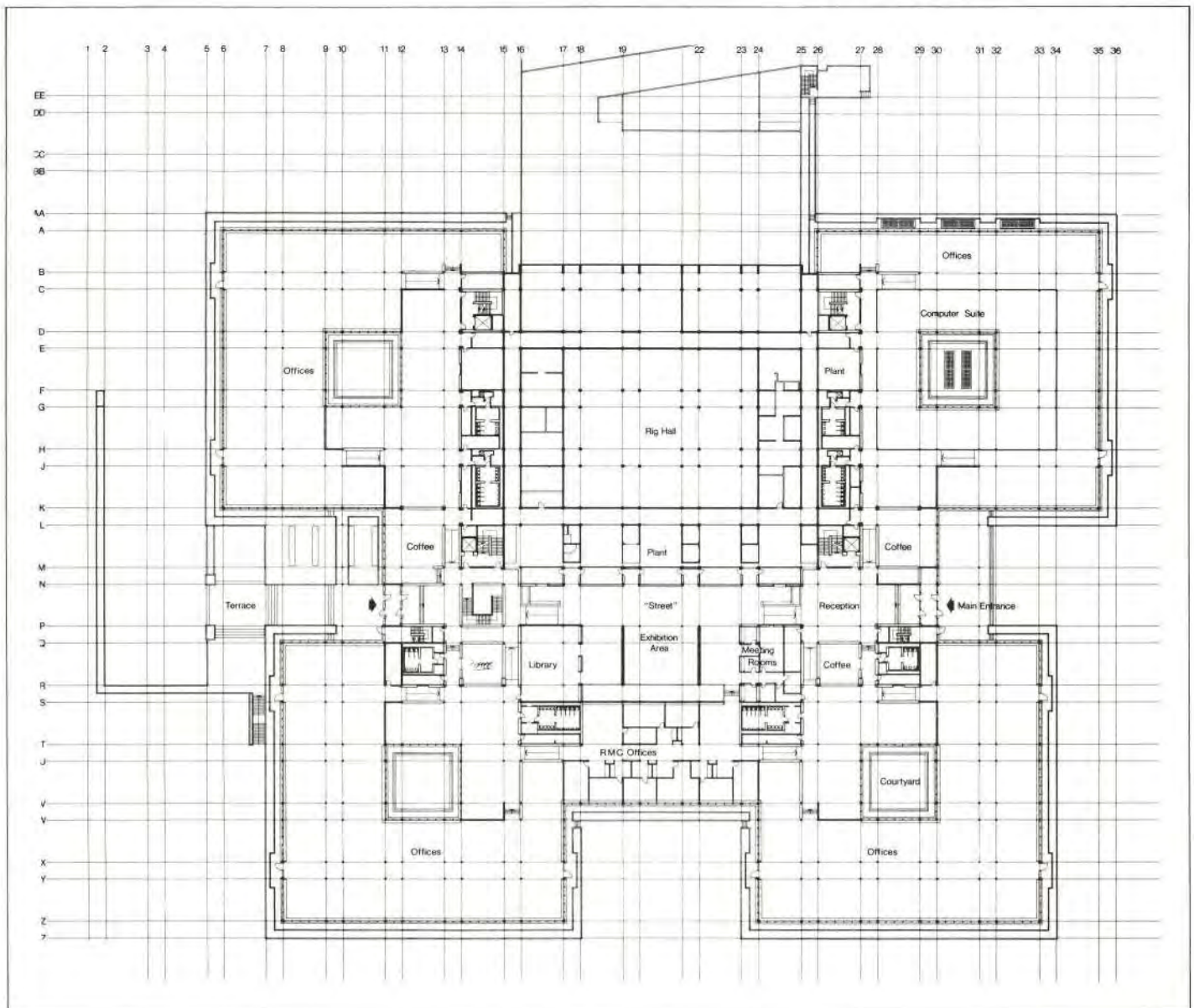

Fig. 7 left
CEGB offices: plan diagram. From a central 'street' all the central communal activities, including banks, shops, staircases to restaurants, exhibition spaces, libraries and so on, are planned. The secondary groupings radiate from top-lit double height squares.

Fig. 8 below
CEGB offices: plan at 'street' level



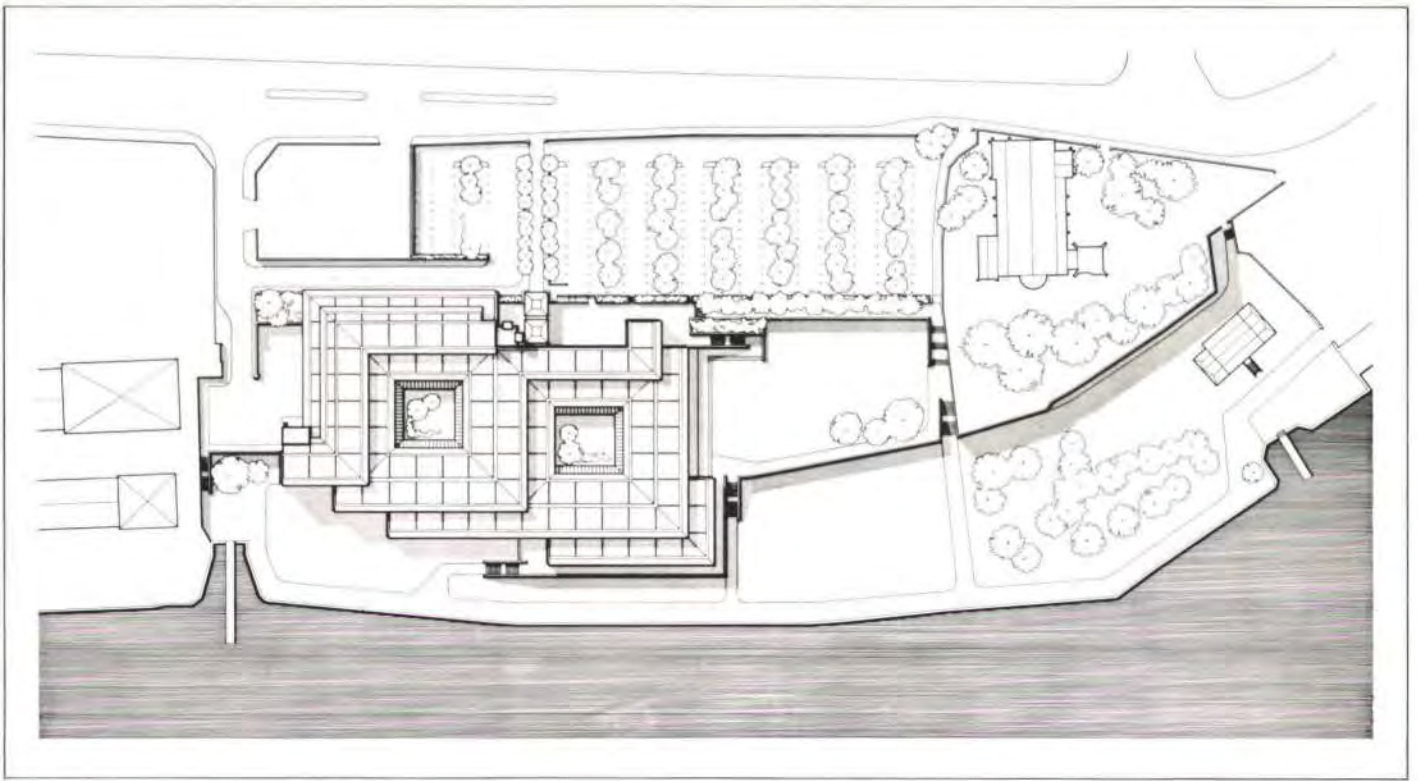

Fig. 9
Lloyd's, Chatham: site plan

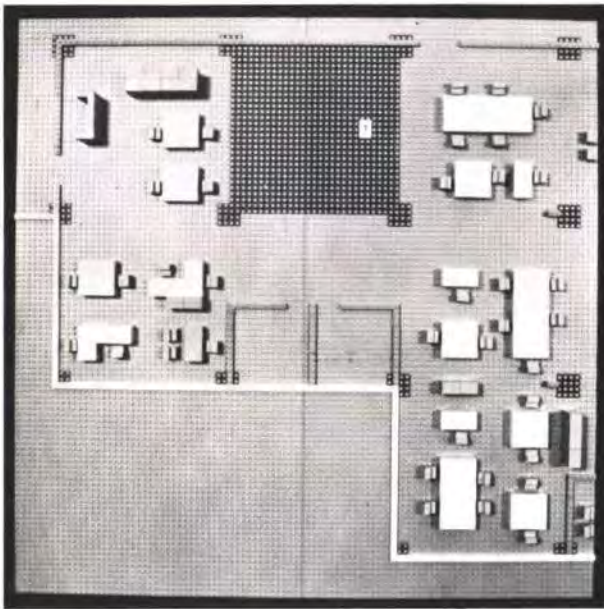

Fig. 10
Lloyd's: typical office layout. Groupings related to structured spaces

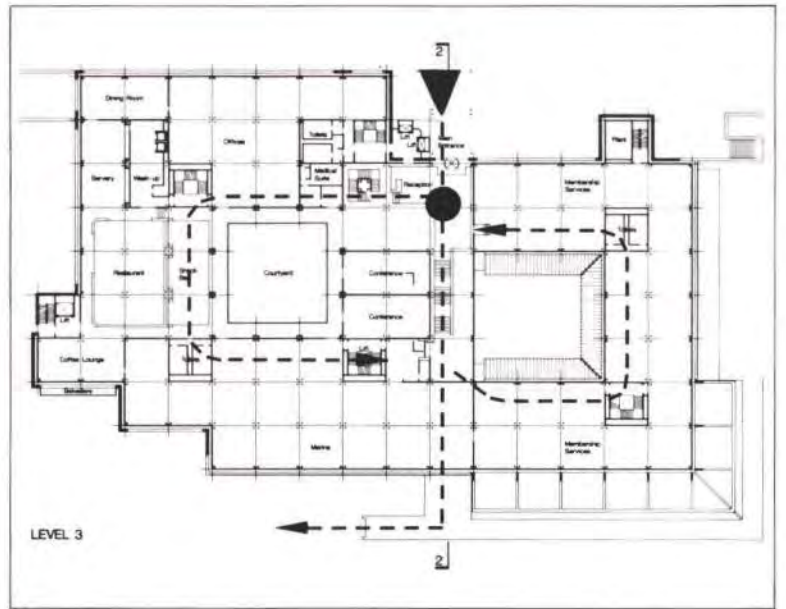

Fig. 11
Lloyd's Administrative Headquarters, Chatham: the planned circulation diagram

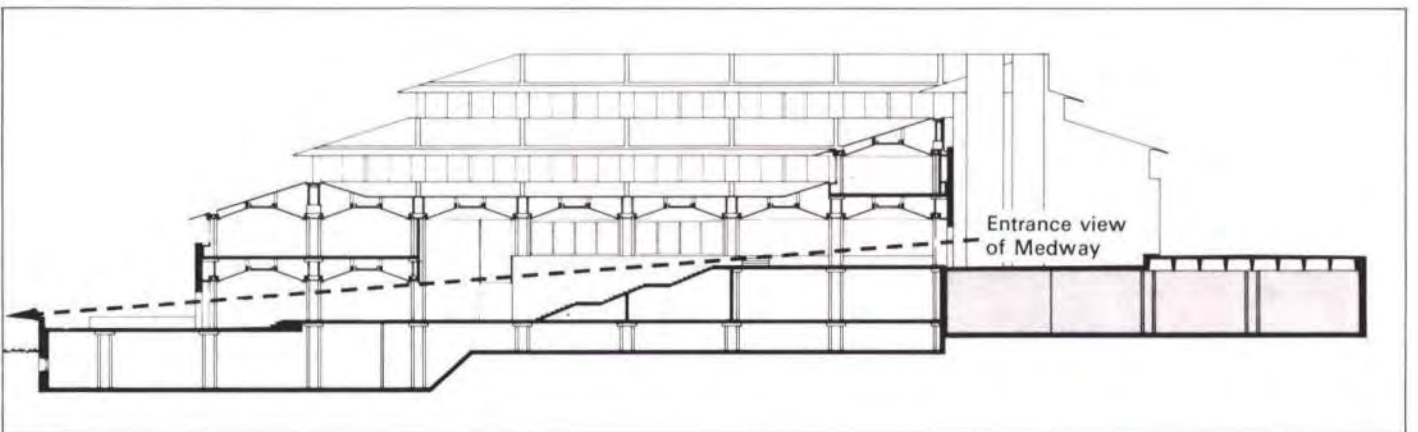

Fig. 12
Lloyd's: section showing relationship to site and primary circulation

Structured space

Leading then from the notion of structured spaces, carefully scaled and connected by eventful circulation networks, I firstly want to consider these in relation to the design of some recent large scale office buildings that Arup Associates are undertaking. Of course, any discussion on the 'structuring' of space must be highly subjective, yet the success of any interiors and the identity that they can lend to the places, will depend upon the way it is handled. We have found for example that the coffered ceiling helped in many ways for office areas up to a certain size of floor plan. Technically it helped the acoustic, masked the lighting and provided the ribs for partitioning. Spacially, it reduced the height in the long view, but increased it to the coffer soffit above one's head, providing a vertical emphasis and so a sense of location. Finally, it is visually so strong an element that it can contain and hold together a good deal of variety, and even a great deal of mess, without the interiors becoming lost. All this is very good. However, beyond a certain size of building, or floor space, or floor plan, coffers would impose a repetitiveness at too small a scale which could be deadening and tedious.



Fig. 13 above
Penguin office building: office interior, with coffered ceiling; visually strong, which helps to contain the impact of normal office clutter

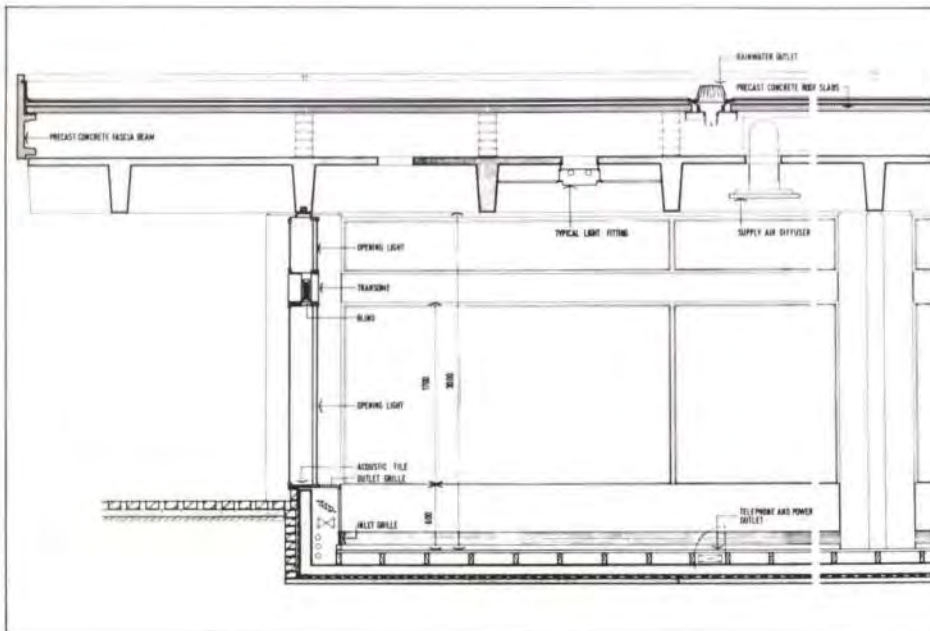
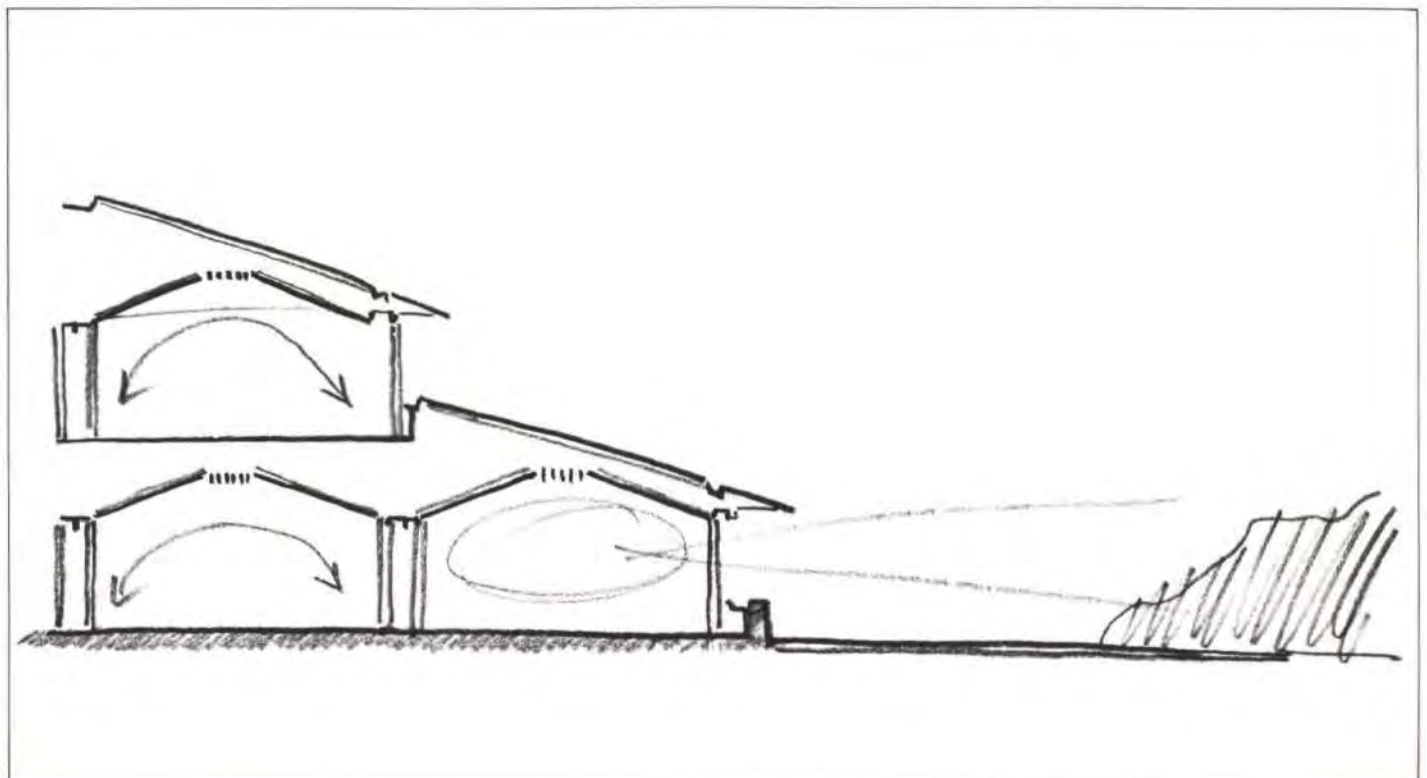

Fig. 14
Penguin office building: section

Fig. 15 below
Lloyd's: diagrammatic section. 'Sense of location'



Larger buildings require larger basic subdivisions.

Historically speaking, buildings composed of repetitive structured spaces organized in a cellular way are common enough, particularly before the advent of steel increased both the options as well as the indiscipline of designers. But there is a need, in a large building, of these properly scaled elements – a kind of ‘molecular’ sub-division. Repeated domed and pyramidal volumes have always had a strong attraction; they create a spacial rhythm, a sense of moving from place to place, and in this respect the design for Wiggins Teape is particularly interesting. The sense of enclosure that these spaces provide can suggest and encourage groupings of people within defined areas. Places are created by strongly articulated structural subdivisions. The perimeter of each space is only 8 ft high, so the full height partitions correspond to the ‘da Vinci man’, standing arm up-stretched, and not to Goliath. These are carefully made places with their construction visibly evident and integral with the architecture. They also imply an underlying intellectual order which provides another means of human reference.

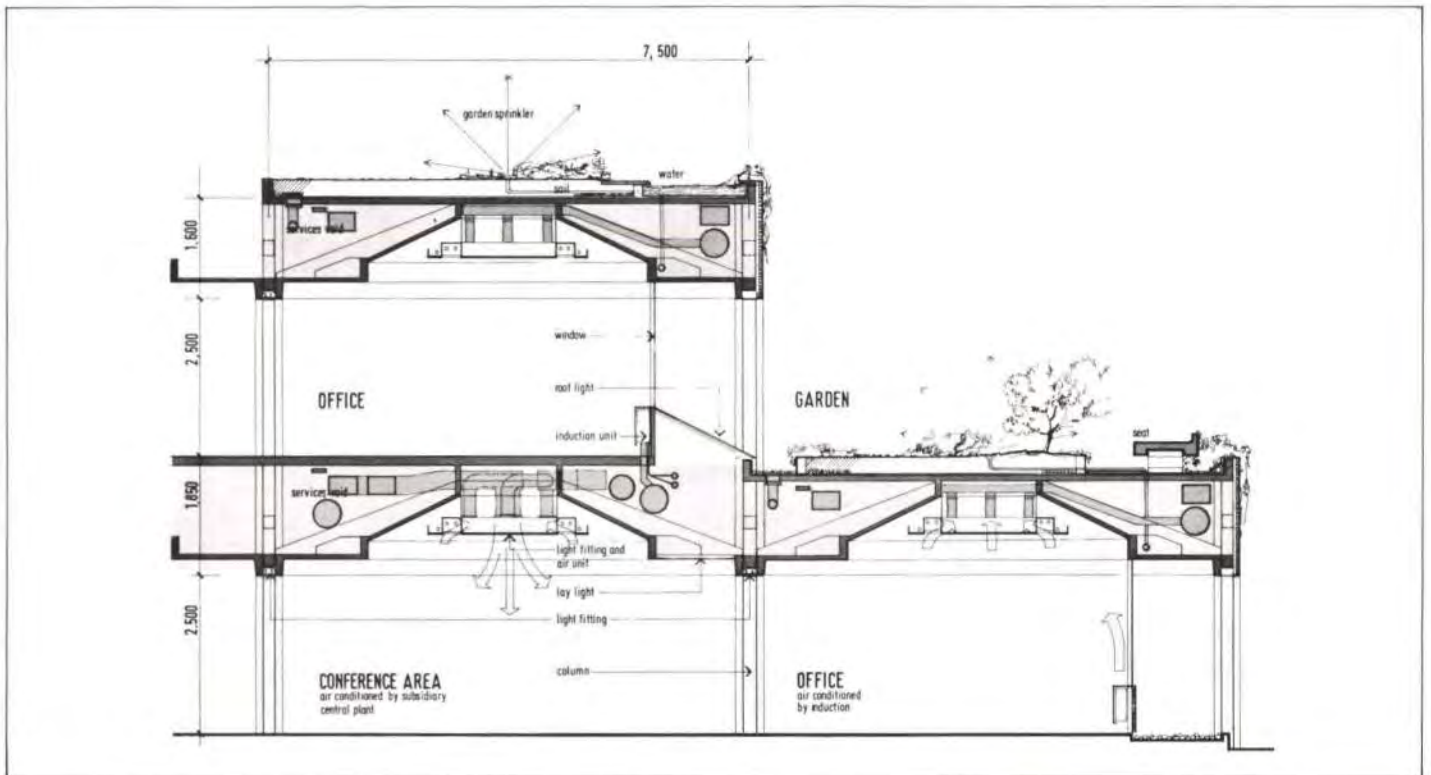

Fig. 16 above
Office building for Wiggins Teape,
Basingstoke: interior showing internal corner,
pyramid spaces, and internal court garden



Fig. 17
Wiggins Teape: sectional model

Fig. 18 below
Wiggins Teape: section showing repeated
pyramidal volumes. ‘Larger buildings require
larger basic subdivisions’



Construction

In recognizing the different design problems of floors and of ceilings, a logical solution is the constructed void. We have been exploring this idea in one form or another since the early days of the Mining and Metallurgy building in Birmingham, and then at Loughborough and, in a different way, with the Penguin office building and the Truman office building, and subsequently with the Lloyd's building at Chatham. This directly follows the solution for Wiggins Teape, but with the same column arrangement as we first used in the Mining and Metallurgy building. This was for the same reasons of vertical services distribution, constructional tolerances, and method of assembly. In the case of the Lloyd's scheme, the pyramids were cast in one piece on the site and erection was very rapid. In the same way that the different design requirements for cladding and structure lead logically to their separation and individual construction, so the acceptance of the quite different requirements of ceilings and floors, with the necessary services, suggests their separate construction as well.

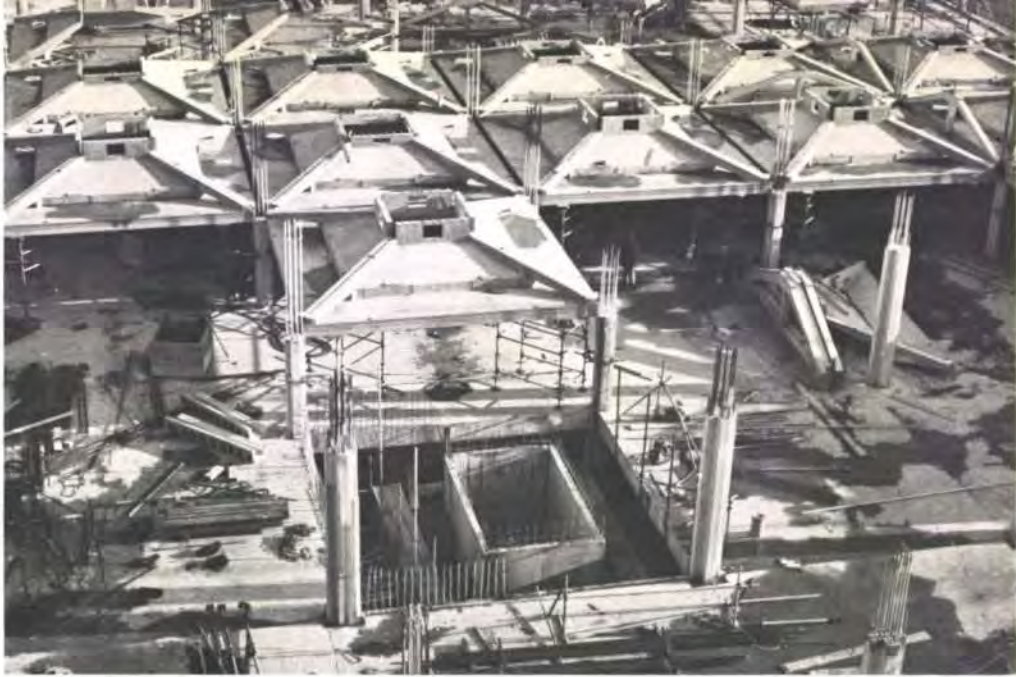

Fig. 19
Wiggins Teape under construction:
7.5 m bays with single columns and edge
beams. Pyramids are precast in four pieces

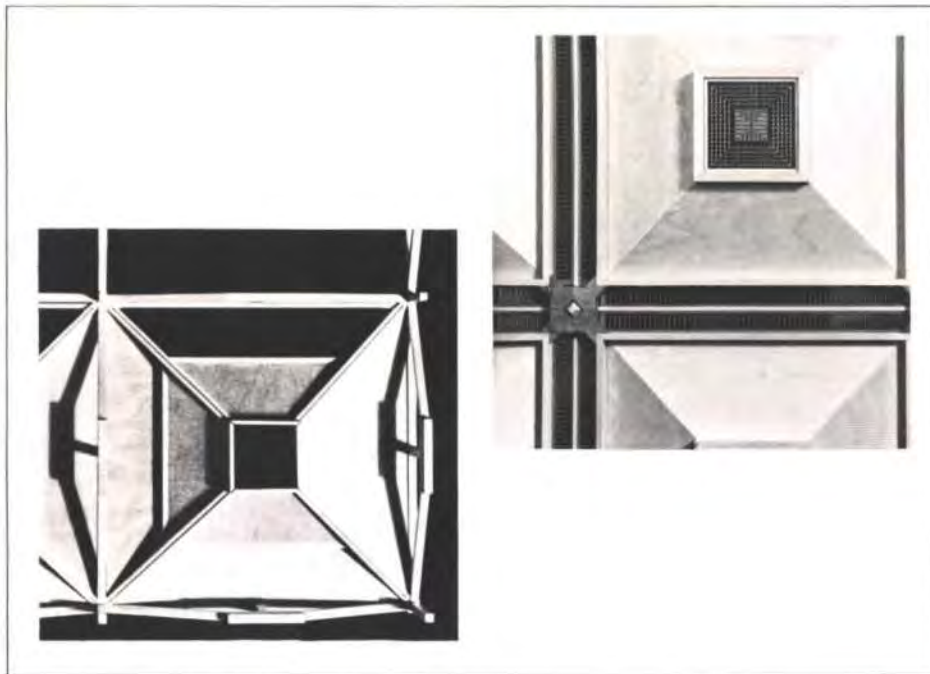

Fig. 20
Comparison: Wiggins Teape and Lloyd's

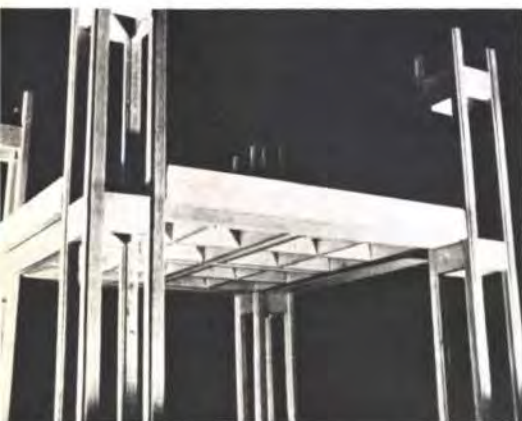

Fig. 21
Birmingham University, Mining &
Metallurgy Building 1964. Study model of
repetitive coffered element. Four columns
25 ft. bays

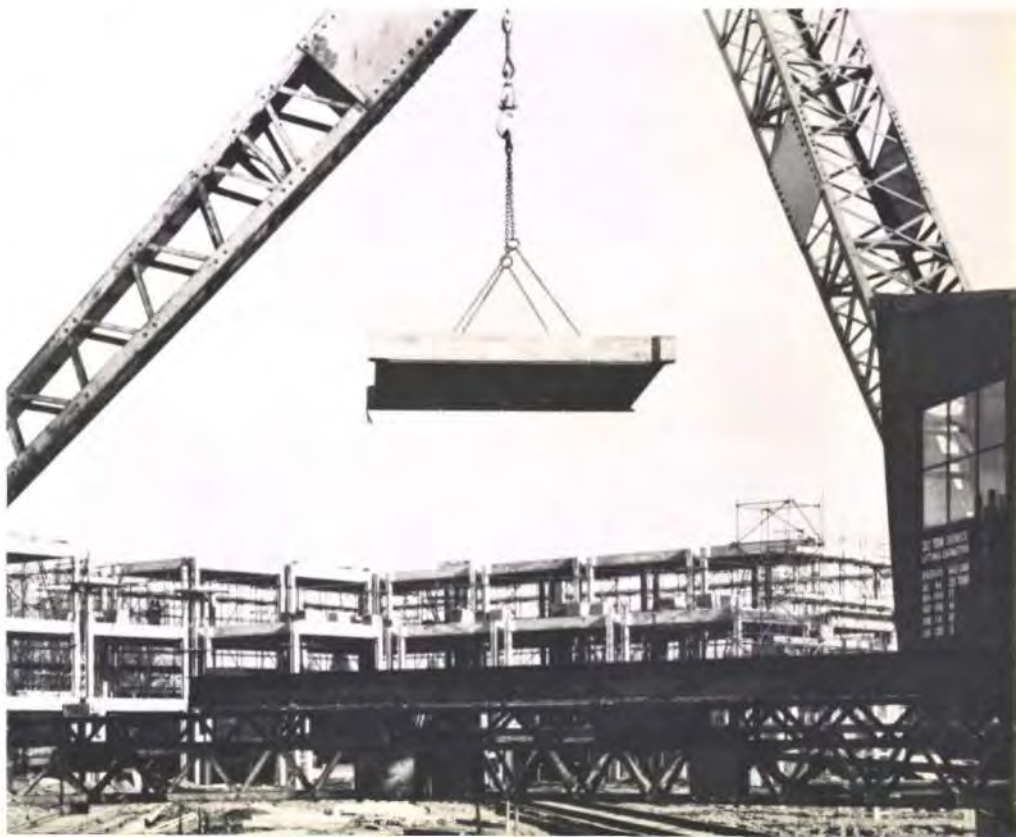

Fig. 22
Mining and Metallurgy building. Erection of
17 tonne precast coffered slab



Fig. 23
Lloyd's Administrative Headquarters:
7.2 m bays with pyramids cast in one with
four columns and no edge beams

Fig. 24 right
Lloyd's sectional model showing 'molecular'
organization

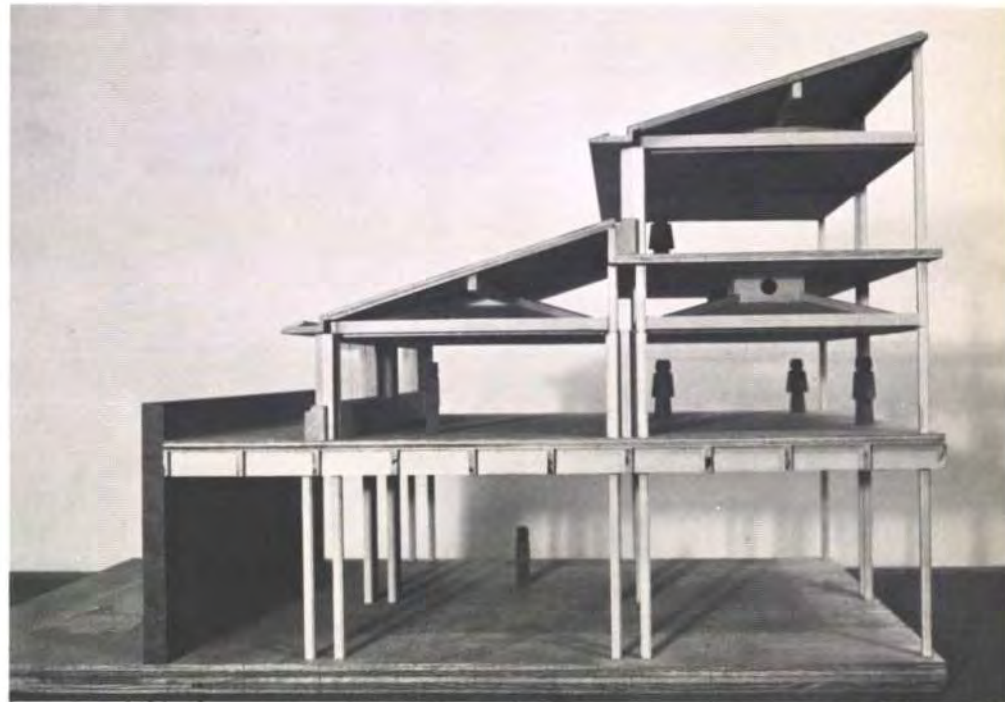

Fig. 25
Lloyd's: erection of an 8.5 tonne precast
pyramid

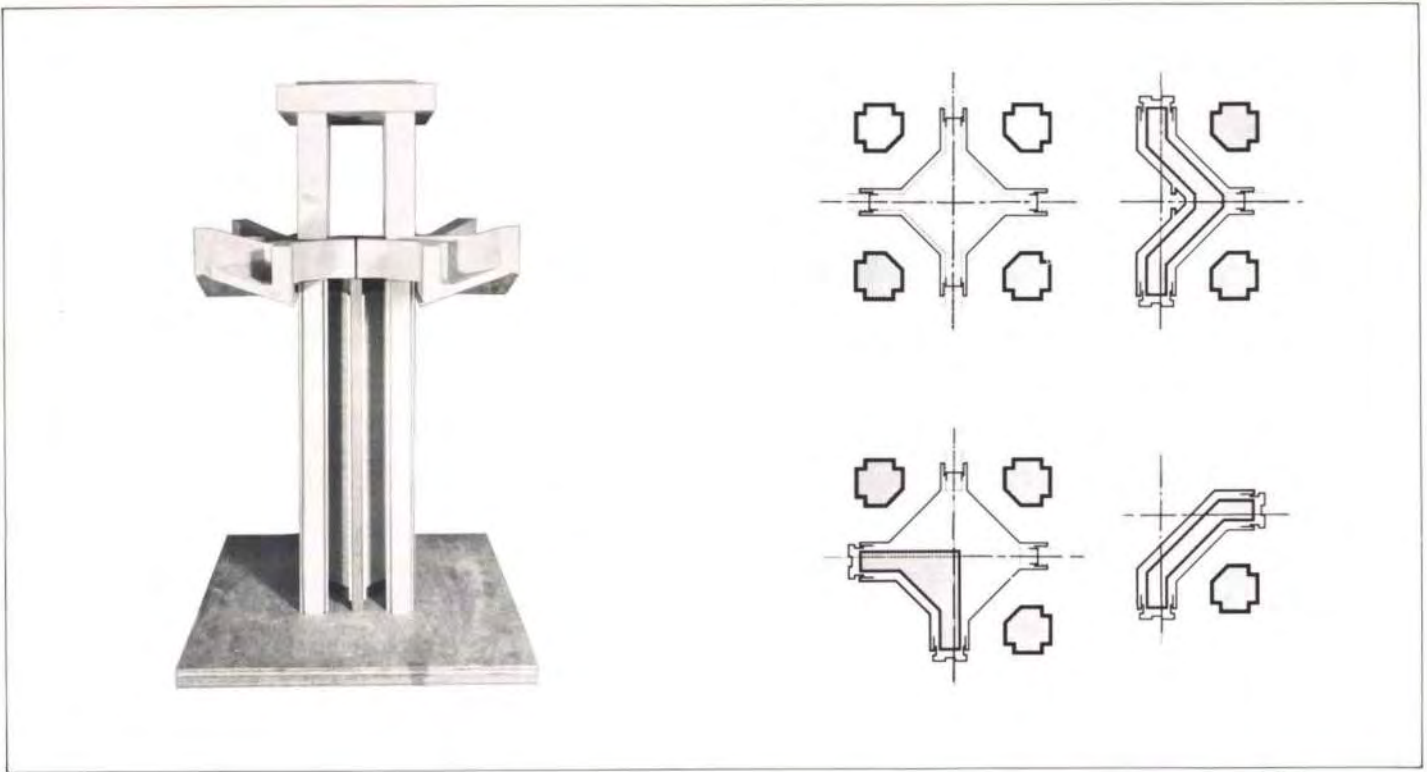

Fig. 26
Lloyd's: four column group with internal cruciform duct. Duct houses various services outlets and provides for partition fixing

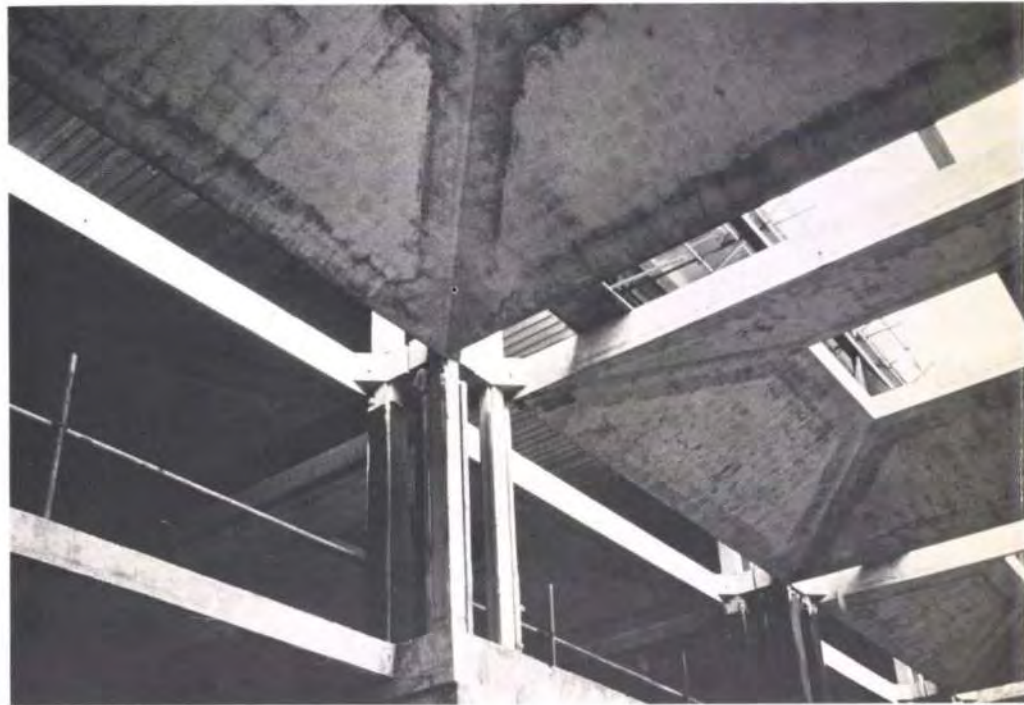

Fig. 27 right
Lloyd's under construction. 'Spaces within'



Fig. 28
Lloyd's interior under construction. 'Structured spaces'. Provision is made for false ceilings in the few places required. Note grooves for possible subdivision of pyramidal spaces



Fig. 29
Wiggins Teape: a focal space external to the building itself



Fig. 30
Wiggins Teape: circulation and emphasis

Location and scale

At the large scale, the strong focal space within the new headquarters building for Wiggins Teape is external to the building itself. It is not a courtyard, but a bowl on the side of a hill. The stepped gardens provide an immediate extension to each office floor, with the larger office areas and terraces on the lower floors. The top floor, which is the smallest and most exposed, has also the most

sheltered terraces. There is thus within the whole building a graduated break-down in scale. The emphasis is towards the centre of the bowl, and to look out of an office and across it is to identify one's place in a larger working community, who share this built landscape, this common ground, as it were. The arrangement visibly binds together the different parts of this large building so that, when moving around and through it, its form and organization are constantly apparent.

Fig. 31
Wiggins Teape: site plan: sloping site, stepped terraces

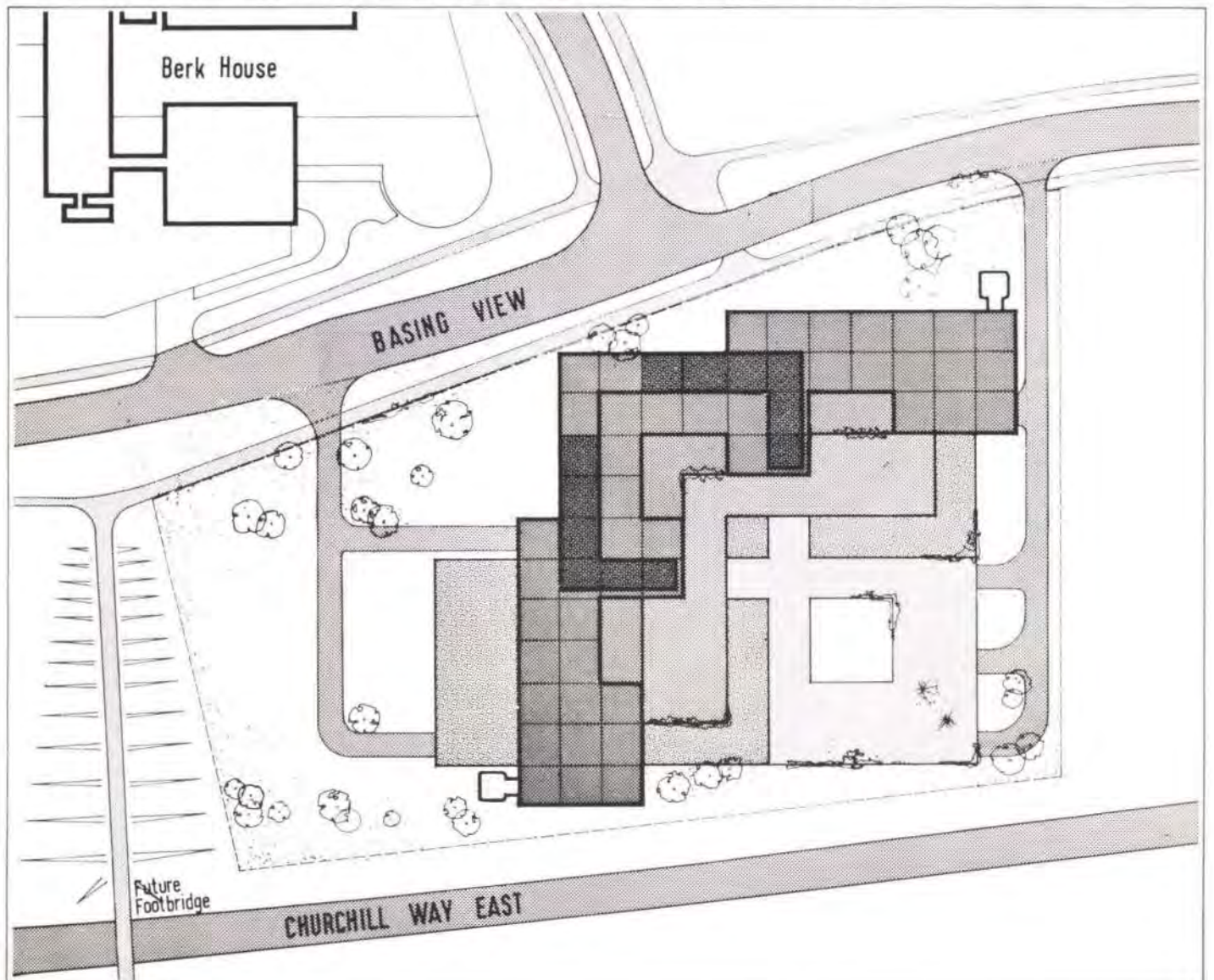
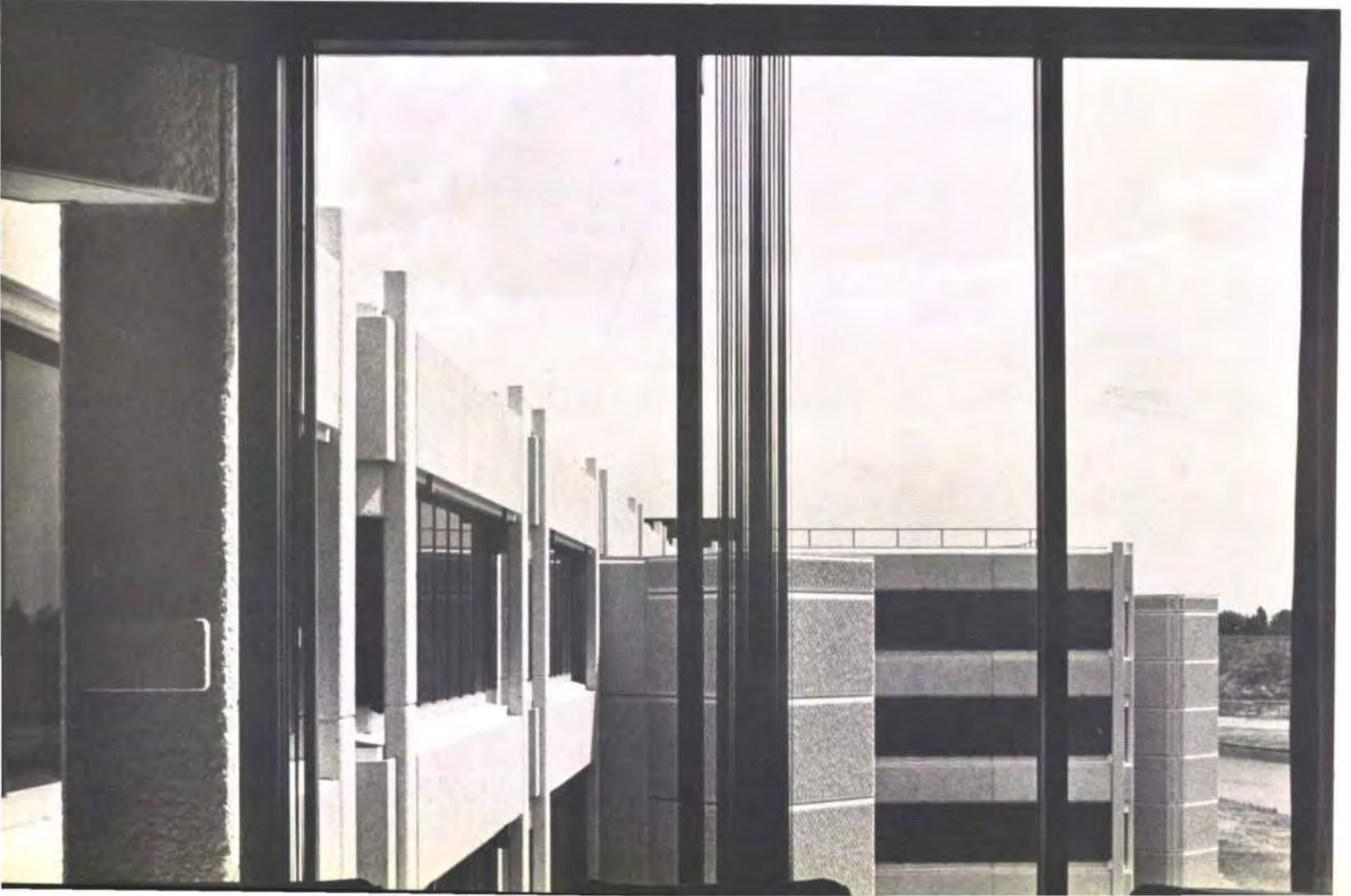



Fig. 32
Wiggins Teape: the views across helping to identify the 'part' with a larger working community

Fig. 33 below
IBM headquarters, Cosham: the views across



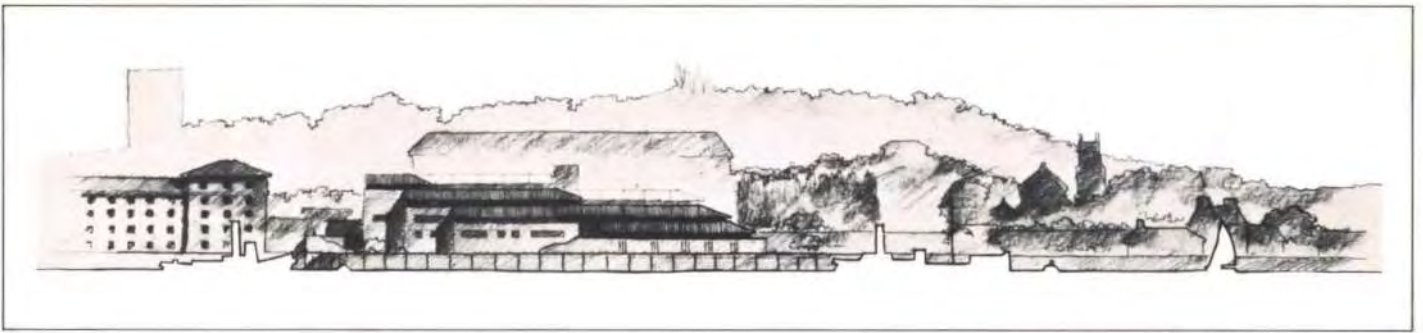

Fig. 34
Lloyd's: elevation from the River Medway.
A large building assimilated within its
landscape



In the case of the new administrative headquarters for Lloyd's, at Chatham, the form is a stepped figure of eight which follows a sloping site. The entrance is at the centre, which at once lays open the whole organization of the building as well as opening views over the river Medway. The roofs and silhouettes are designed to conform with the contours and consolidate the character of the site, as is also the case in the design for the new headquarters for the Central Electricity Generating Board near Bristol. The scale in both cases is reduced around the perimeter, which makes them look deceptively modest in size. A close relationship is therefore easier to achieve with the landscape, which becomes a direct extension of various parts of this large Lloyd's complex. The 'stepped roofs' embody the windows within these 'steps' and the roofs themselves provide the weathering for the structure as they do over Gothic vaults.

Fig. 35
Model of CEGB: general view of building in
relation to the site

Fig. 36
Lloyd's general site plan. A stepped figure of
eight follows the terraced site. From the
entrance the whole organization of the
plan can be understood

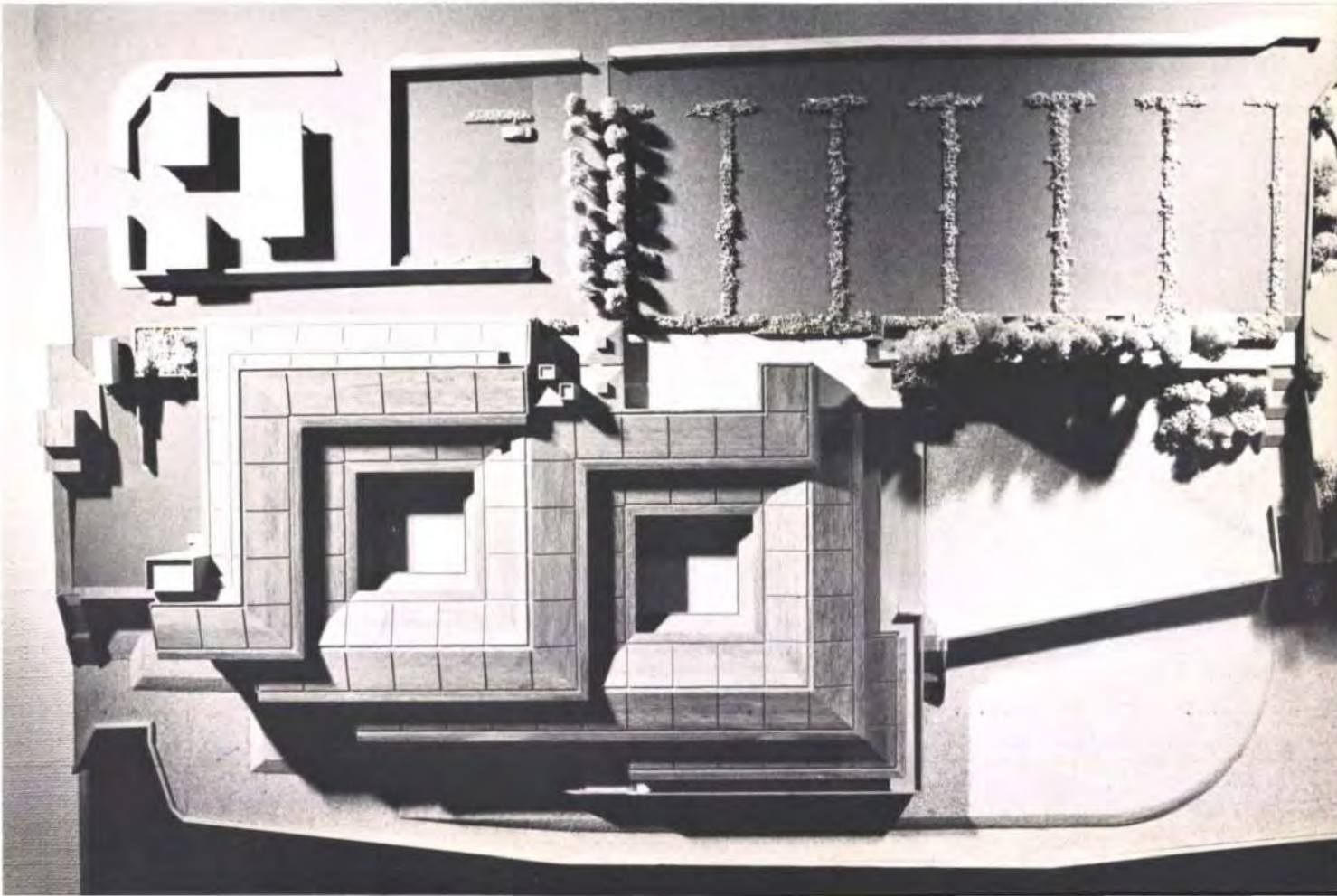

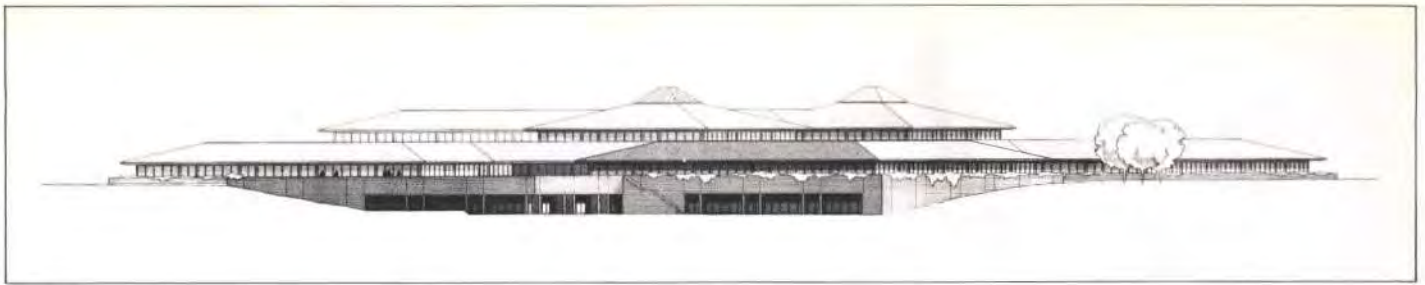

The importance, however, of circulation design can more readily be demonstrated in the new building for Trumans, in Brick Lane, (Fig. 1 and pages 4 & 5), and in the CEGB building (page 6) where, in both cases, it is spinal. In Brick Lane the two sides of the site are linked by a large conservatory, heavily planted, which also has access to all vertical circulation as well as visual contact with bars, conference rooms and so on. This conservatory includes access routes at different levels which connect together the major parts of the site and the various buildings themselves, both new and old. The response of the users indicates that a routine function has succeeded in becoming a pleasure. The close relationship between the work places and amenity areas – available alike to everyone from whatever grade – has also proved very successful. Together, they have created a social focus for the whole community that works there. In one sense the circulation pattern might be said to be a little theatrical, but it does provide a stimulus common to all, in a fairly grim part of London. For this same reason, and at the detail scale, the carpets are green, and the walls brick, naturally lit from above where possible. The planting in the conservatory and the lattice screens in the restaurant all help to bring back the sense of natural things – something of an oasis in hard surroundings.

Fig. 37

CEGB offices: elevation. The low perimeter and the broken roofline silhouette reduces the scale of this large building, and helps to locate it more gently into the landscape

The southwest headquarters for the CEGB is a much larger development, which is planned to accommodate upwards of 1200 people. In this case the plan is organized about a central 'street', with a covered courtyard as its focus, from which all secondary circulation is attached. Within this central 'street' all the central communal activities, including banks, shops, staircases to restaurants, exhibition space, libraries and so on are planned. The secondary groupings radiate from top-lit double height squares. Further definition is provided with changes of level which follow the form of the land. Beyond these secondary areas are finally the individual desks. There is in the whole design a scale breakdown from the centre to the perimeter. The reduction in

scale runs through everything, spaces are reduced both in section and plan, the finishes become more domestic towards the work stations. It is intended that there should be a sense of heightened presence and activity at the centre of the building, which is the place that everyone shares and, conversely, a sense of arrival and relaxation and privacy at the desk. Finally, there is the scale of the building in the context of the landscape which inevitably has an overriding influence on the design. Bedminster Down is a beautiful site and the 'street' has been designed consciously to draw the landscape in at both ends and link them together in a central garden court which, again, has become a conservatory.

Fig. 38

Truman's: trees and reflections, the contrast of old and new carving out a distinctive place in a fairly grim urban setting



Energy

The idea of a whole building being considered as a thermal wheel is a simple one. That is, after all, the nature of old buildings with 3 ft thick walls and small windows. However, to use natural conditions as far as possible to temper the internal environment within new office buildings, as at CEGB, to meet sophisticated demands, is an altogether different and fascinating problem. This requires that the designs work down to much more stringent and limiting conditions which substantially increase the interdependence of the various building elements. The relationship between task lighting and heat loads, for instance, or natural lighting and planning depth or structure with integral air distribution and main planning and so on, becomes interrelated in a particularly close and new way. This complicates the design problems, but in a sense results in a simpler and more broadly based solution. This opens a whole new field of design possibilities to be explored. The notion of using advanced technical design methods to simplify the actual built solutions rather than to complicate them, and to provide more technically elegant and economic results, appeals greatly. Whilst, technically speaking, the energy savings can be dramatic, what is even more intriguing is the effect this approach can have on the quality of the buildings and the interiors themselves. Perhaps it may not be too far-fetched to think that in working back towards limiting natural conditions, inevitably the designs will move closer to the conditions to which people can more easily respond.

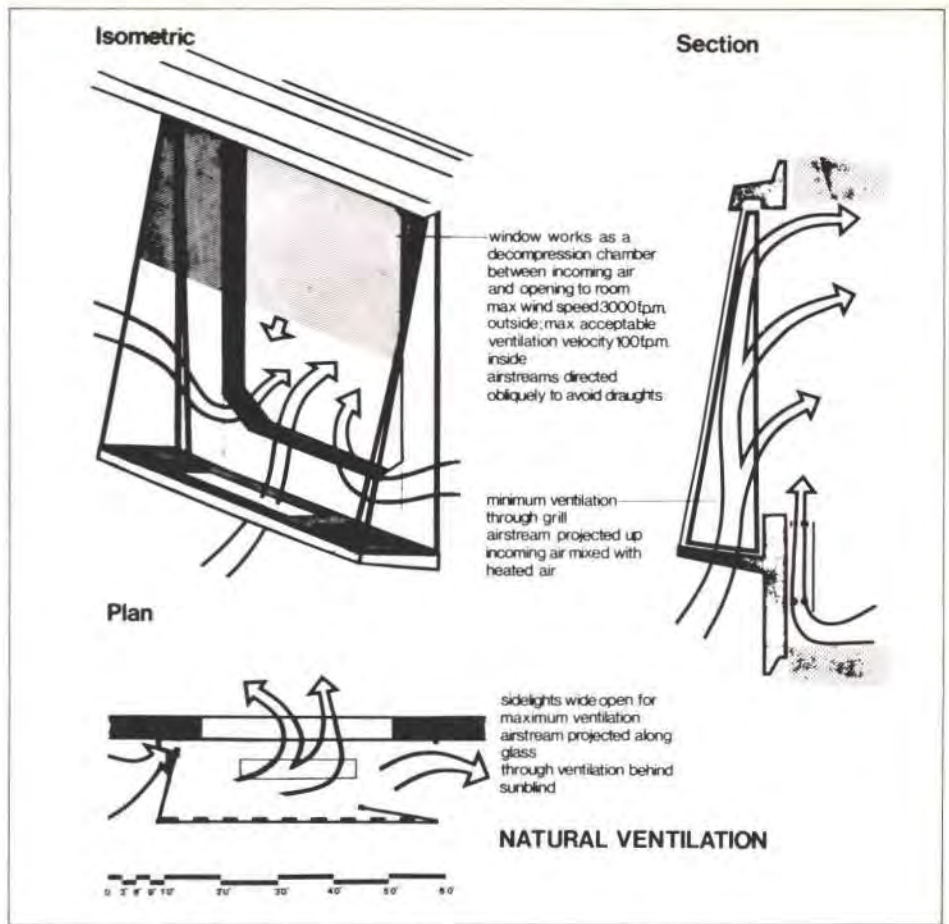

Fig. 39 Leicester University, Arts & Commerce Tower, 1964: diagram of the natural ventilation system

Fig. 41 'Window' with sunblind half down. Ventilation occurs behind the plane of the blind



Fig. 42 View from an office through opening. 'Window' framing not visible



Fig. 40 Task light and desk



Fig. 43 CEGB cross-section: the thermal mass of the floor slabs cooled at night are used to modulate the internal environment by day

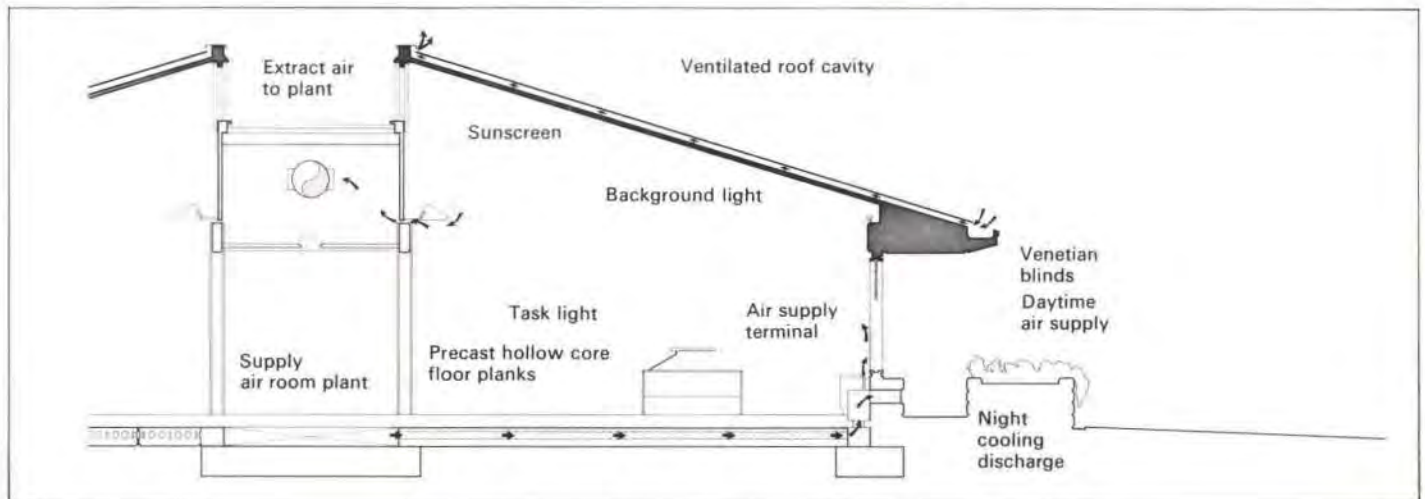

Office towers

Ideas of structured spaces with eventful circulation systems are relatively simple to apply in low and spreading buildings, but the problem changes where the emphasis is vertical; an office tower for example. Nevertheless, they can still apply. The interior character of the IBM tower in Johannesburg is largely created by its vertical circulation. The lifts enclose circular or semi-circular spaces, naturally lit, with dramatic strip views over the city, providing a strong reference point for each office floor. The materials of the exterior and interior of the circular lift tower are similar, further emphasizing its form and particularity. A double 'skin' clads the external walls of the offices and separates out the exterior and interior functions of an external wall. The internal skin is an extension of the partition system which can allow windows to be placed to meet the particular requirements of the plan, on the assumption that 50% or more of these partitions will be insulated and so solid. The whole is sheathed in bronze glass, including external ducts and columns, designed as a curtain without horizontal members. The space between the skins provides access for rearrangement of panels as well as maintenance.



Fig. 44

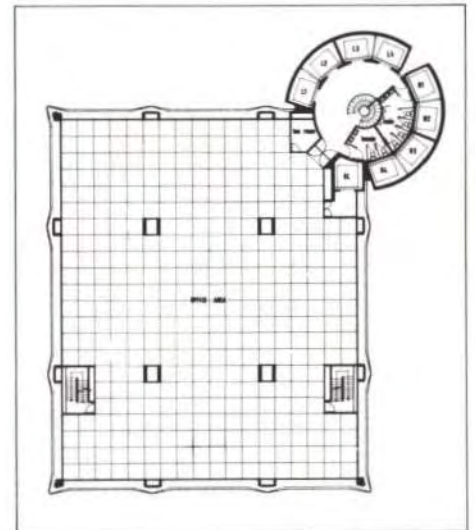

Fig. 46
IBM Johannesburg: typical plan

Fig. 45
IBM Headquarters, Johannesburg: reflections



Fig. 47
IBM Johannesburg: external core with low and high rise lift segments

Fig. 48
IBM plan: typical corner with partition, grid and 'double skin'

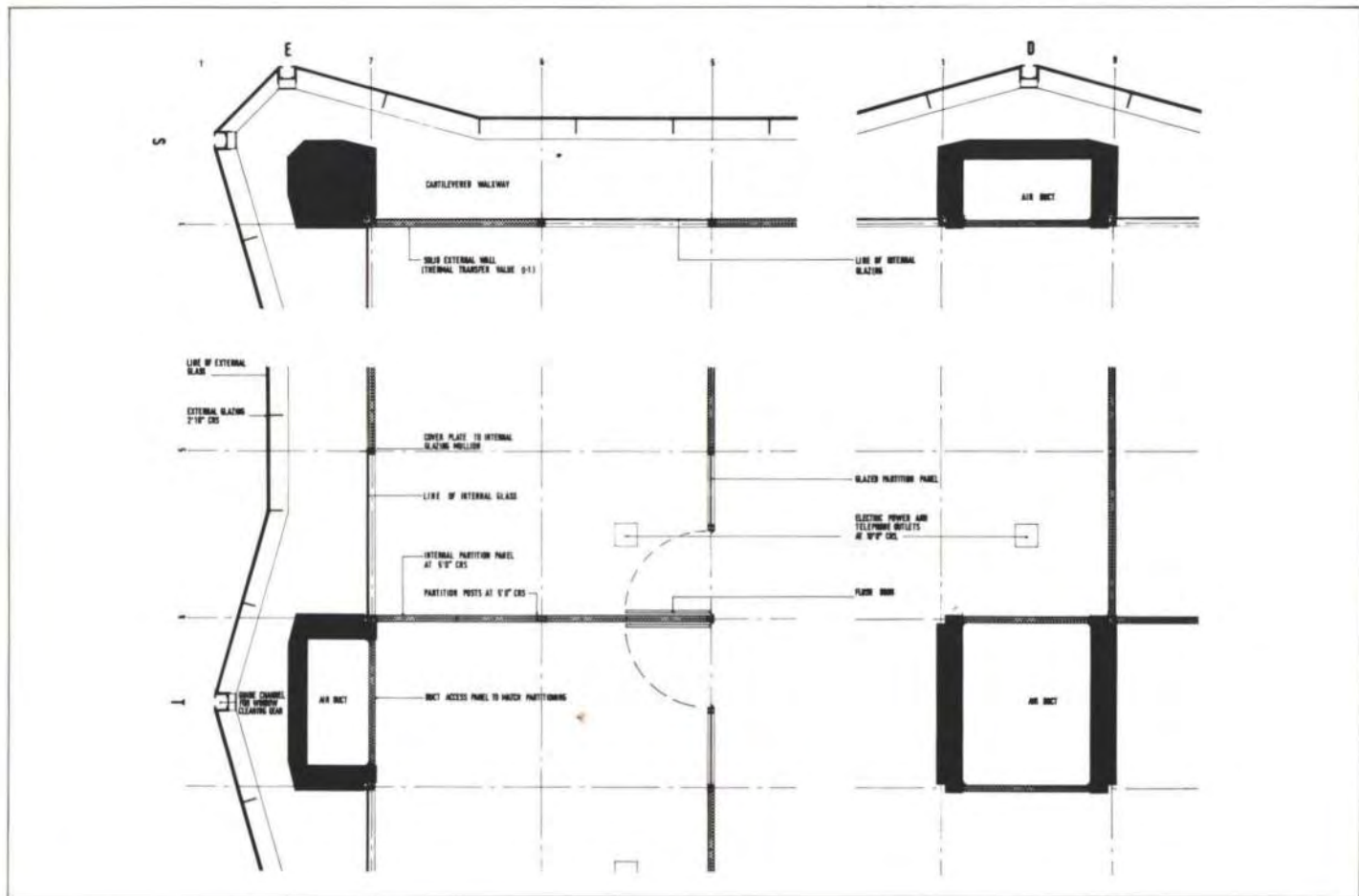

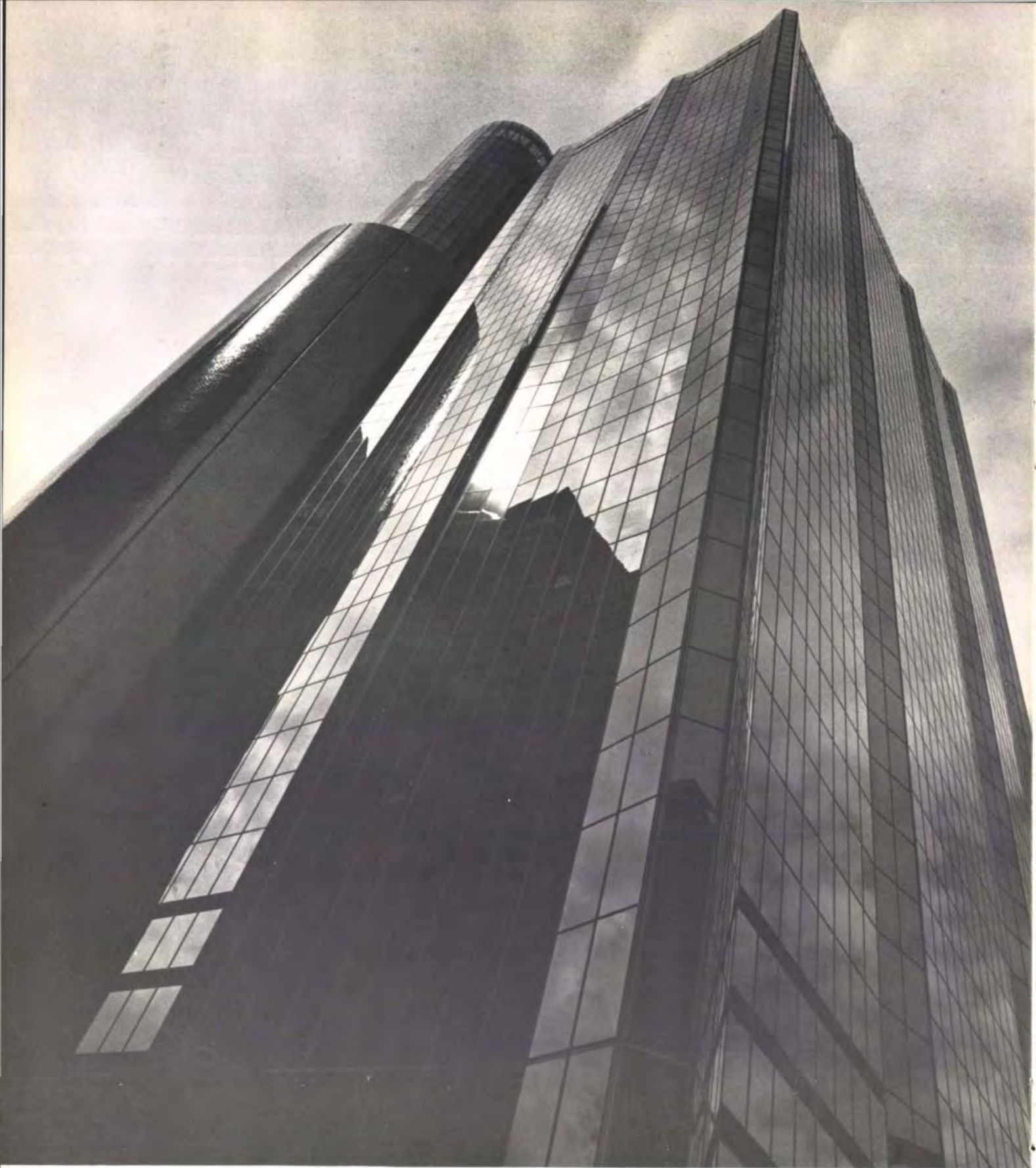

Fig. 49
IBM Johannesburg: circular service core with
high and low rise lift shafts expressed

If handled imaginatively, by the users, the opportunities that this solution provides are very considerable. Certainly it is adaptable and plans can correspond to the requirements of aspect and assist with energy conservation, but this arrangement can also allow for planning individual spaces uniquely, without the overlay of rigorous window patterns – be they 'hit and miss' in one form or another, or continuous ribbons of glazing which are more common – that are such powerful determinants in the design of offices. No two floors are the same and the randomness of the partitioning as seen 'through a glass darkly' creates a total elevation which is 'more than the sum of the differences' and speaks for

what it is – recognizable, appropriately enough perhaps, as a punch card is recognizable. The lift and service tower and the offices have a clearly stated architectural relationship, and each aims to be descriptive of its own purpose. In the city scene, the effects of light across its curved and sharply crystalline forms reduces the visual mass of this large building. The fractured and constantly changing reflections that these forms produce give light and sparkle to the building. The cost? – no more than a quality single skin, with the attendant difficulties of solving all the problems in two dimensions only. The snag? – its adaptability is so readily abused.



Fig. 50
Reflections and the play of light and fractured images reduce the apparent mass of the building



Fig. 51
The elevation showing the random arrangement of partitions on the inner skin



Fig. 52 below
Point of arrival. The lift lobby and spiral stair



Fig. 53
Arts & Commerce tower: Lecture theatre and seminar rooms in low block linked to 17 storey office tower

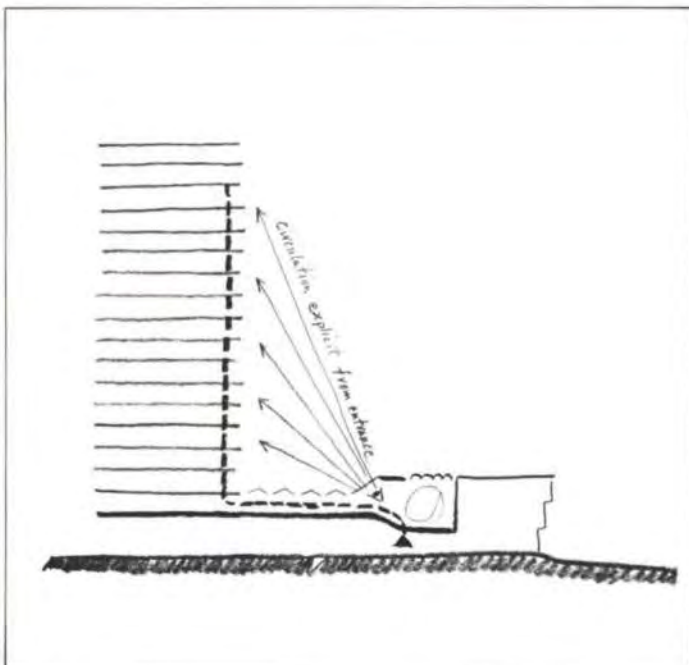

Fig. 54
Leicester Arts and Commerce tower: circulation diagram. Departmental colour coded lobby screens visible through glazed roof of entrance link. Destination thus signalled. Emphasis on an explicit circulation design

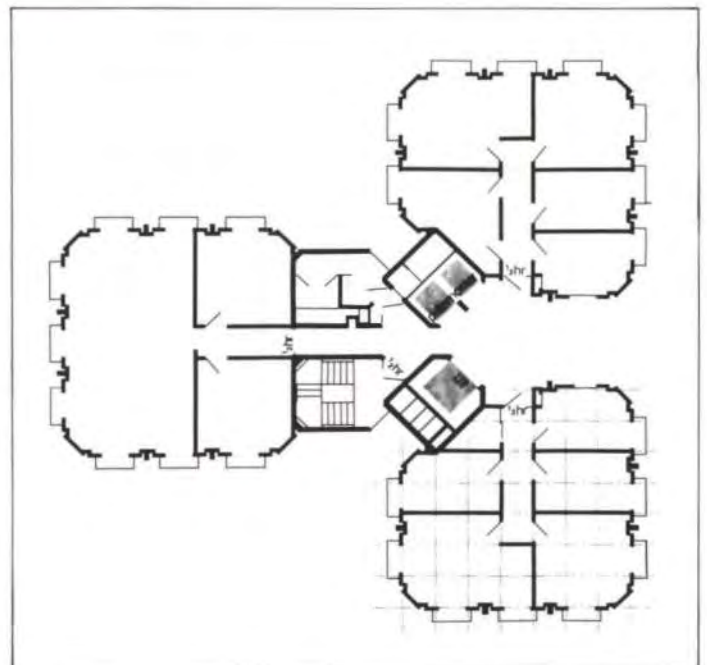
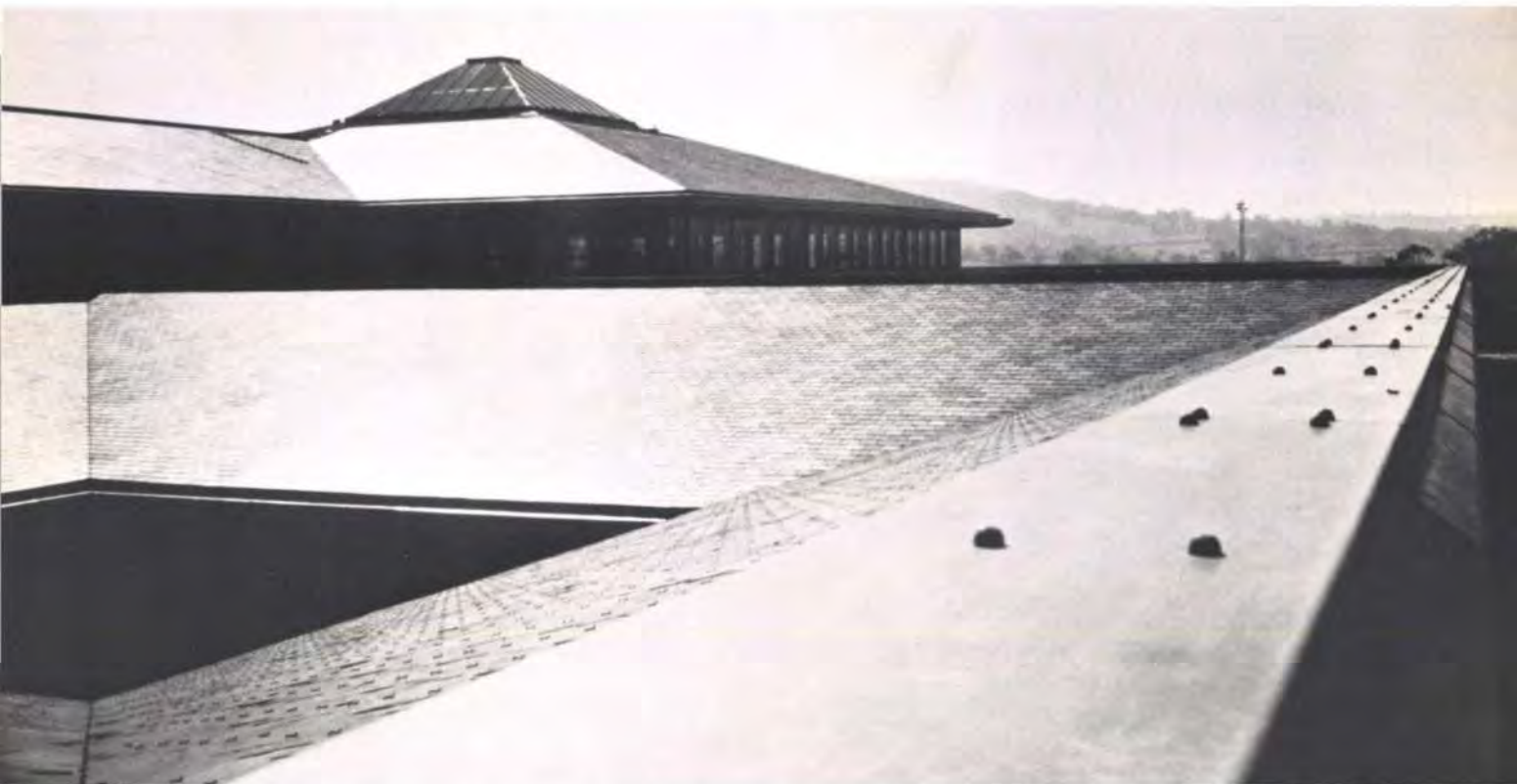

Fig. 55
Arts & Commerce tower: typical 'trefoil' floor plan. The whole building is naturally ventilated



Figs. 56 and 57

Above: Lloyds Chatham and below: the CEGB building at Bedminster Down: Roofscape as seen from within and implying the wider community



It is said that when the Cambridge University Press moved into their new air-conditioned headquarters, the staff missed the higgledy-piggledy, dark, dusty, noisy and inconvenient old slums that they had left. The quiet, ordered and separated layout of the typesetters, for example, produced in them neuroses, not delight. When prefab 'swift plan' is preferred to expensive open plan, as happened once with us, one needs to stop and think. The human animal is very adaptable and can more readily adapt to change than buildings ever can – indeed, his metabolism requires it. The space craft designers realized this when seats with a perfect fit were made from the impress of an individual person. They were comfortable only for a limited time, until all the blood cells

on the body's surface started to become dulled simultaneously. A shape was needed to induce in the astronauts the right degree of 'wriggle' for the cells to function properly. Air-conditioning systems are now sometimes designed to create variable eddies of air to provide the necessary stimulus in an otherwise inert environment. The lesson is clear. The patrons of palaces and great country houses have gone, and have been replaced by the princes of commerce and industry. The formality and ritual of the life of the former have also gone. Many of the attitudes, however, linger on and have imperceptibly found their way into architectural gestures in the 'Grand Manner' more appropriate to a 17th century Cardinal Archbishop than a Limited

Liability Company, and into Utopian parkland settings more reminiscent of Claude than the industrial hearths of their origin. Cinderella may have left her smokey chimney and married her prince, but they are still in need of a marriage guidance councillor! When all is said and done success will ultimately depend upon the users. Here one can only hope for a perceptive response to the design on their part – assisted by persuasion! – and for a recognition of their own role. Nevertheless, an office building cannot be distinguished and neutral. Finally if it is to be unique to a place, a use and an organization, it requires a particular balance and understanding between the architecture and the management which can sustain the changes of its working community.

Byker Viaduct

Bill Smyth

Introduction

Byker Viaduct is the major structure in the Byker Contract which is one of the two sections of the Tyneside Metro for which we are consulting engineers. The Byker section consists of an approach section, the viaduct, retained fill, Byker Station, lengths of cut and cover tunnel and open cut, and Chillingham Road Station, about 3 km long in all.

The viaduct is about 800 m long and the plan alignment is an S-bend. The site consists of two distinct parts. At the west end there is the Ouse Burn Valley, the floor of which is about 30 m below the viaduct. Here the viaduct runs between two earlier structures, a road and a rail viaduct. The sides of the valley are very steep and it is about as awkward a place to build a bridge as one could find. After the viaduct leaves the valley it runs at a height of about 6 m above a gently sloping hillside for the rest of its length.

The bedrock is coal measures overlain by boulder clay and weaker clays with lenses of gravel and made ground. Under the valley

there are old mine workings and there is a fault across it. There is also the Ouse Burn.

The main live loading conditions on the viaduct arise from passenger trains travelling quickly on both tracks, or from works trains which are heavier but slower. Centrifugal forces are significant, particularly for the tall valley columns.

The valley section and the Byker Hill section give very different conditions for building a viaduct. The valley is awkward to get to and to work in, construction is at a considerable height and foundation conditions are difficult, whereas the other section is much more straightforward, although it does include

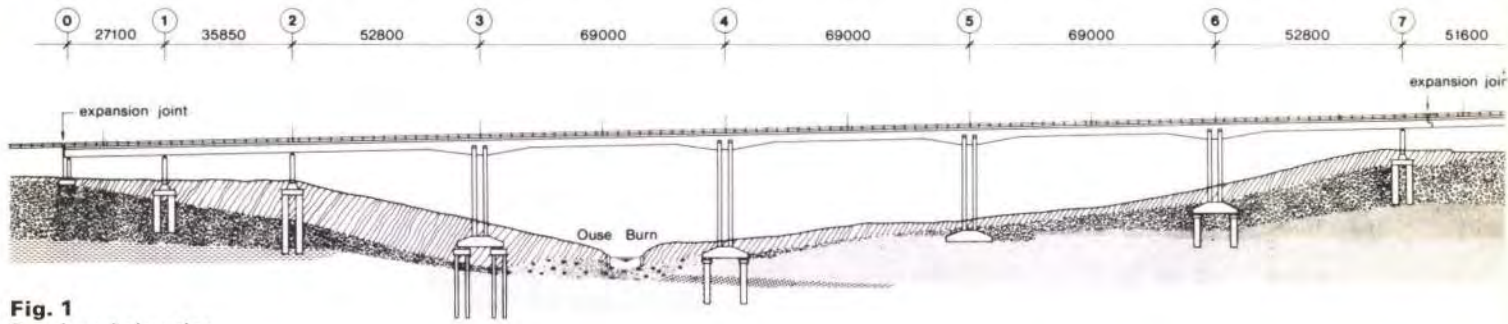

Fig. 1
Developed elevation



Fig. 3
The viaduct curves around to cross over the road. Pier number 7 is at right of picture

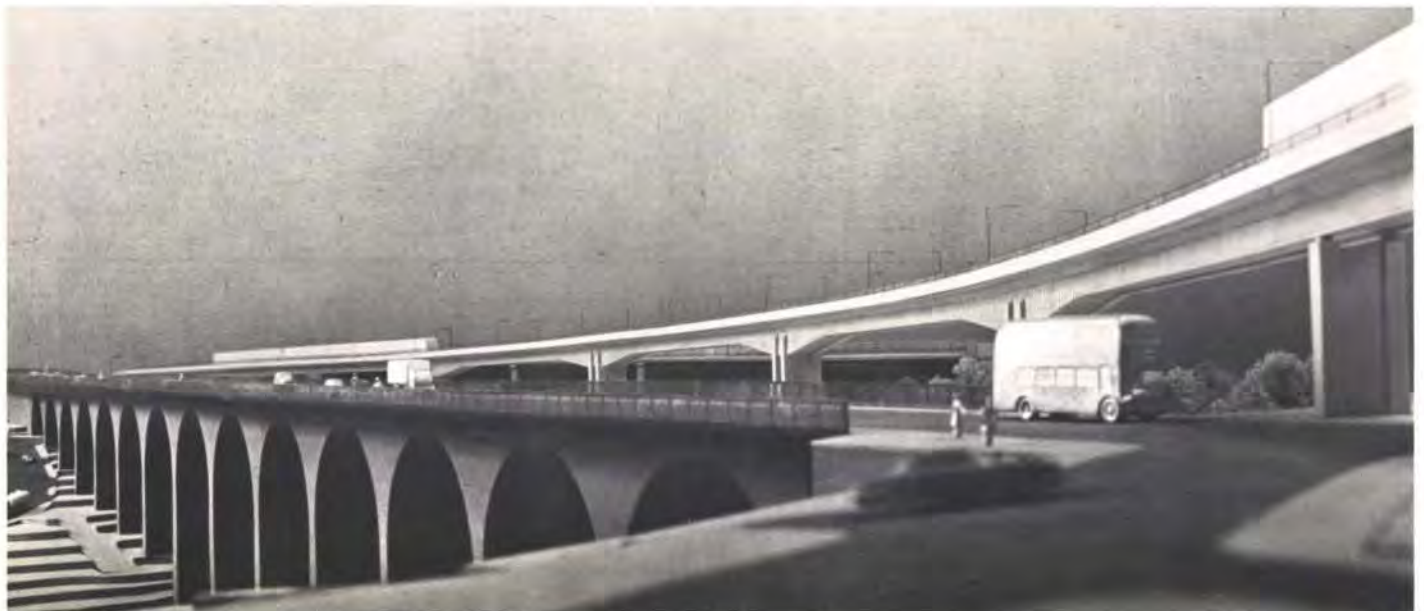

Fig. 2
The new viaduct runs across the Ouse Burn Valley, between a road viaduct (foreground) and a railway viaduct

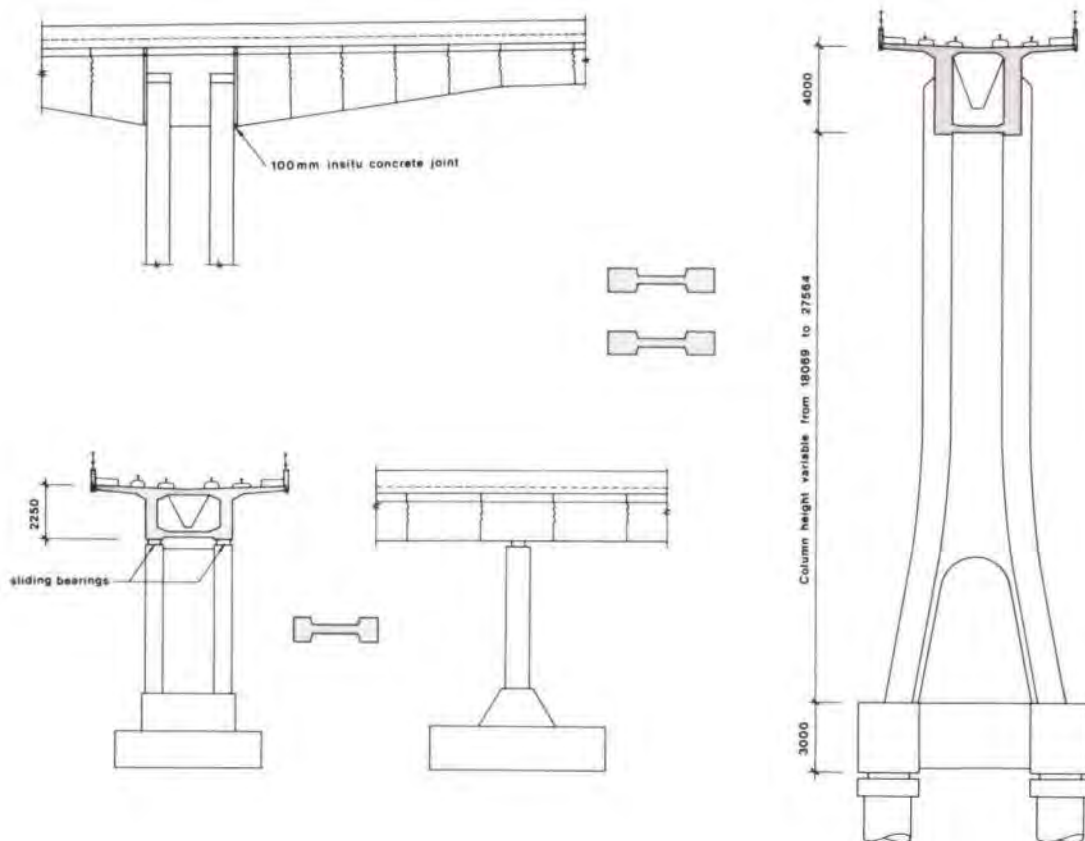

Fig. 7
Typical single column and typical double column

(where spanning falsework would be too expensive) and normal span-by-span construction on falsework elsewhere. Extrusion (casting in fixed forms at the abutments, and pushing out) was briefly looked at, and so was segmental construction with in situ concrete joints. Finally we decided to detail the structure for segmental construction with matched casting for epoxy resin joints. This seemed likely to be the most economical way of building the viaduct and it would leave the option of cast in situ cantilever construction for any tenderer who might prefer it.

We thought that a suitable launching girder would be too expensive, and so we designed for the use of a simple shearlegs and winch hoist sitting on the nose of the cantilever. One result of this for the balanced cantilever construction across the valley is that the columns have to be built up to the top of the deck so that the hoist can sit on top and lift up the first deck units.

The main valley spans, with their haunches, are designed to be built as balanced cantilevers (i.e. never more than one segment plus hoist weight out of balance). The columns with two thin leaves are stiff to applied moments but flexible to sway forces in the long direction of the viaduct and they have to be cross-braced during construction. The splay in the lateral direction is needed to take the considerable sideways forces acting at deck level, and the hole at the bottom is big enough for the segments to pass through, so that the hoist does not have to slew to pick them up.

The spans on Byker Hill are designed to be built as continuous cantilevers using temporary props.

The big valley columns are generally founded on four large piles, one at each corner. During construction the effect of the fault was found to extend much further than the soil investigation had indicated and one of the foundations

had to be modified to use four smaller piles at each corner. Before constructing the piles the mine workings were grouted. Other foundations are pads in boulder clay.

Two prestressing systems are used. Bars which are coupled at each joint are used to clamp successive segments together and provide part of the permanent prestressing force. Multi-strand cables threaded through ducts in a number of segments provide the greater part of the prestress.

There are four expansion joints including two at the abutments. The internal expansion joints are halved joints which are cast in situ.

The viaduct is going to be a prominent feature of Newcastle and will be seen from far off and close to. A good deal of care was given to the arrangement and proportions of the various parts of the viaduct and to detailing it for weathering. The columns and the parapets are going to be most exposed to weathering and they have been given a vertically ribbed finish with the outer face of the ribs tooled to expose the aggregate.

Construction

When the scheme went out to tender we half expected that there might be alternative construction methods put forward but, although some tenderers made threatening noises, in the end there were no alternatives. The successful tenderers were Mowlems.

The viaduct segments are being cast on site using the adjustable pallet technique. Each unit is cast between a fixed stop end and the end of the unit previously cast. The soffit shutter is a pallet on wheels. After a unit is cast and the side forms removed, it is moved forward on its pallet and rotated into a position where the next unit can be cast against it, with relative orientation of the two units to give the correct alignment when erected. The relative positions are measured before and after casting and any measured error allowed for in the next unit cast. The

ideal casting cycle is one unit per day, but the average is rather slower.

There are internal diaphragms only at the supports and where the haunches cause the soffit to change angle. In order to simplify the segment casting the diaphragms are constructed as a separate operation.

The segments are cast in a shed with overhead hoists using an ingenious system of steel pallets and mould sides devised by Mowlems and Stelmo. Mowlems designed a special hoist – shearlegs and winch – for erection and a purpose-made rig on a low loader which is used for handling the units and moving them to and from their stored positions. Rail tracks are used to lower segments down the slopes of the valley. They run directly under the viaduct and through the holes in the columns and the segments can be lifted straight up into position.

Trials were carried out in thickening the epoxy joint with layers of fibreglass. This was to enable the units to be 'steered' during erection and this has been successfully done for vertical and horizontal alignments. All the evidence we have so far indicates that the relative orientation in the casting yard is reproduced faithfully in erection. There are, unfortunately, ambiguities in the measurement of twist in the casting yard and these have led to problems during erection, because it is more difficult to correct twist than the other two rotations.

Credits

Client:

Tyne and Wear Passenger Transport Executive

Designers:

Ove Arup & Partners, Civil Engineering Division

Architect: Humphrey Wood of Renton Howard Wood Levin Partnership

Main contractors:

John Mowlem & Co. Ltd.



Fig. 8
Stacked segments. Near the centre is a segment with a diaphragm (Photo: Bill Smyth)

Fig. 9
Part of the viaduct on Byker Hill. The casting shed is on the right and the Byker Wall can be seen through the viaduct (Photo: Bill Smyth)



New head office for the Scottish Widows Fund and Life Assurance Society, Edinburgh

David Colley

Introduction

The life assurance business has flourished in Scotland since the early years of the last century and the top Scottish companies have enviable track records, comparing well with those of the other leading companies in the United Kingdom.

The Scottish Widows Fund & Life Assurance Society is one of these companies and dates back to the very beginning of the life assurance business in Scotland. It was established in Edinburgh in 1815 as a mutual society with the aim of setting up a fund for 'securing provision to widows, sisters and other females'. From 1822 until recently the Society has had its head office in or near St. Andrews Square, the square which is reputed to contain the highest concentration of financial institutions in the world.

After 1962 Scottish Widows increased its business and staff to such an extent that it became necessary to look for large new premises. They were fortunate in being able to acquire a magnificent 2.5 ha. site towards the

outskirts of Edinburgh overlooked by Arthur's Seat and the Salisbury Crags. In close proximity are the Royal Park, the Royal Commonwealth Swimming Pool, and the University Halls of Residence.

Sir Basil Spence, Glover & Ferguson, who had previously designed the head office building for the Society, were appointed to design the new head office on this site. Planning consent and approval from the Royal Fine Arts Commission and the Scottish Development Department were obtained in early 1972 and construction work started in July 1972. The building was officially opened in July 1976.

Architecture

The importance of the site was recognized by the planning authorities and restrictions with regard to maximum height (15.2 m), plot ratio (0.75 to 1) and choice of materials were imposed.

The building has been designed as a series of interlocking hexagonal modules, irregularly arranged in plan and varying in height from three to six storeys. The building above the 'ground floor' is clad entirely in brown glass whilst extensive use has been made of riven York stone on the lower walls, exposed by the stepped site.



Fig. 1 below
Aerial view of completed building with covered car park on right hand side of photograph (Photo: J. Inglis)

Fig. 2
Bulk excavation complete, October, 1972 (Photo: A. L. Hunter)



modules were cast later to allow thermal movement, due to the heat of hydration, to take place first.

Since each module is completely self-supporting, movement joints could readily be provided between modules with very little modification to the structural detailing. However only one movement joint through the centre of the building was considered necessary.

Detailing of the reinforcement was complicated due to the fact that there were large diameter bars running in three directions in both the bottom and top of the slab. The lever arm of the third layer was thus significantly less than that of the first. The 600 mm deep edge beams, spanning 13.5 m, require the maximum lever arm and therefore could not make use of the second and third layers, which further complicated the detailing.

The heavy vertical bars in columns had to be positioned by means of templates to ensure that they would not clash with the rib reinforcement and in particular the very heavy top mat reinforcement over the central column.

Since the standard floor and roof slabs were repeated in total some 36 times, it was important that the complex detailing of the reinforcement should be gone into thoroughly. The considerable effort that was put into ensuring that every bar would fit and could be physically positioned paid off on site, where the steel fixing went relatively smoothly.

The roof slabs were identical to the floor slabs except that in order to provide falls, the centre of the slab was lifted by 600 mm, producing a slightly folded hexagonal slab. This further complicated the detailing of the reinforcement in that the rib reinforcement had to be lightly cranked at each fold and at a different position for each rib.

Concrete finishes

Certain of the coffered slabs have exposed soffits and the perimeters of all slabs at the ground floor level are exposed externally. A very high quality, smooth finish with no visible shutter joints was required by the architect.

In order to achieve this the edge beam shutters were lined in situ with a vinyl floor covering and all joints carefully welded and sanded down. Joints between the GRP coffer pans were recessed and taped but, as always, these caused a few problems.

Soffits cast on new coffer pans were quite remarkable on first stripping, being akin to highly polished black marble, but the colour soon toned down to the normal colour on exposure to the air.

The circular columns throughout the building are exposed and again a very smooth, jointless finish was required. After much experimenting, it was concluded that this could only be achieved by using jointless GRP shutters having a 50 mm taper from top to bottom to permit the shutter to be stripped vertically.

Some very good columns were produced from new shutters but it was found to be extremely difficult to obtain consistent results. It was essential for the shutters to be absolutely free from damage and dirt and for the release agent to be evenly and thinly spread. Many factors appeared to affect the results and the technique was never really mastered.

The GRP shutters had to be returned several times to the manufacturer for refurbishing, but in spite of these problems a high standard of finish was eventually achieved. Some of the best results were obtained with the 5 m high columns using a 100 mm taper. The taper on the columns is hardly discernible in the finished building.

Curtain walling

Each cantilever slab supports a storey height of glass walling. The architect wished to emphasize the vertical lines of the cladding and



Fig. 5
Typical finishes within restaurant area (Photo: Henk Snoek)



Fig. 6
Floor slabs of a typical module showing perimeter ventilation ducts being installed (Photo: A. L. Hunter)



Fig. 7
Typical elevation (Photo: Henk Snoek)



Fig. 8
View of building from landscaped car park roof (Photo: Henk Snoek)



Fig. 9
Pool at main entrance
(Photo: Henk Snoek)

required the depths of the transoms to be kept to a minimum. The transoms would normally be designed to accommodate possible differential deflections between floor slabs as well as thermal movements of the cladding. In order to reduce the depth of the transoms, twin steel spacing tubes, designed to tie the perimeter slabs together vertically, were positioned at mid-span of each external edge. This made it possible to size the transoms to cater for thermal movement only, thereby reducing their depth by up to 30 mm.

There was the danger with this arrangement that a heavily loaded edge beam, wanting to deflect more than the ones above and below, would transmit heavy loads into the spacing tubes through the 100 mm slabs. To overcome this problem the 100 mm cantilever slabs were reinforced to carry the maximum possible downward reaction, but with very little bottom reinforcement passing into the supporting edge beam. This effectively produced a one-way hinge allowing the edge beams to deflect downwards in relation to the propped ends of the cantilever, with little resistance.

A mock up of a short length of edge beam and cantilever, incorporating this one-way hinge, was constructed and tested using hydraulic jacks and dial gauges. The joint was found to perform well.

Hanging staircases

The main stairs are located in the two service modules and provide access to six levels. Each stair, constructed in mild steel plate, is suspended from the roof slab by means of six 25 mm diameter steel rods. The rods were fabricated in lengths equal to the distance between landings and joined at each landing level by means of specially designed threaded couplings which also transferred the stair loads to the rods.

Services

The building is fully air-conditioned and to cope with the problems associated with the large areas of glazing, a system of mechanically-ventilated double glazing has been employed. The system was originally developed by a firm of Swedish consulting engineers and developed for the Scottish Widows' building in association with them, by Steesen Varming Mulcahy & Partners. The window wall incorporates an outer layer of 10 mm thick, brown solar glass and an inner layer of toughened, clear glass. Venetian blinds are contained within the 60 mm air space between the two panes.

Air from the office is drawn through a slot in the bottom of the inner pane, across the venetian blind, into the ceiling void and then returned

to the central air handling plant for re-conditioning and re-circulation. Solar gain into the building is calculated to be about one half of that through conventional double glazed windows. A further advantage is that the inner skin of glass is maintained at virtually the same temperature as the room, eliminating cold radiation and allowing staff to work in comfort close to the glass. A constant volume air supply of varying temperature services the perimeter of the building. This, together with a window extract system, effectively deals with external conditions and a variable volume system deals with internal loads imposed by the occupants, lights and office equipment. Air is exhausted through the light fittings to remove a large proportion of the heat generated by the fluorescent tubes.

An independent air-conditioning system is provided for the computer suite.

The boiler and refrigerating plant are housed in a plant room remote from the main building and partly hidden by the landscaped gardens. The plantrooms, containing mechanical, electrical and extensive communications equipment, are located in the sub-basement and are linked to the two vertical service cores which serve the floor areas.

A sophisticated, computerized control system has been installed to control all air-conditioning, water services, lighting and certain electrical switchgear.

In the landscaped office areas floor outlet boxes give access for telephones, power and visual display units and a document conveyor system links each floor to the archives and post rooms.

Contract

It was apparent from the beginning that the new head office would be a complex building to design and construct. The client wished the building to be completed as soon as possible and appointed Bovis Fee Construction as managing contractors in the summer of 1971 to join the design team in the preparation of the contract documents and to package the various sections of work into separate sub-contracts. This made it possible to start on site several months earlier than would otherwise have been the case.

The project finally involved over 50 sub-contractors, each one having to be closely co-ordinated by the managing contractor to comply with a tight programme and a demanding specification.

Edinburgh's heritage

Edinburgh has a unique architectural heritage and over 20 preservation societies ready to protect it. The siting of the Scottish Widows' building on the site, which at the time was occupied by a disused printing works, provoked a public inquiry.

It is interesting to note that this modern building, which is in striking contrast to that which is normally accepted as being proper for the City, has been received with a complete absence of hostile criticism. The building has received a 1977 RIBA Award.

Credits

Client:

The Scottish Widows Fund & Life Assurance Society

Architects:

Sir Basil Spence Glover & Ferguson

Mechanical and electrical engineers:

Steensen Varming Mulcahy & Partners

Quantity surveyor:

J. D. Gibson & Simpson

Landscape architect:

Dame Sylvia Crowe & Associates

Managing contractor:

Bovis Construction Ltd.

Subcontractor for structure:

Taylor Woodrow (Scotland) Ltd

The Tower at Doha

Michael Willford
David Croft

INTRODUCTION

It is proposed to build a symbolic tower at Doha in the State of Qatar in the Arabian Gulf. The architects for the project are William L. Pereira Associates of Los Angeles.

The tower will be located on a man-made island in Doha Bay roughly 450 m from the shore and connected to it by a causeway (Fig. 1). The structure is to be 100 m high and will consist of two reinforced and prestressed concrete toroidal-surfaced lattices (Figs. 2 and 3). A restaurant will be located at mid-height with an observation deck at the top, and access to these will be by means of a central core containing lifts, stairs and services. A radio/television antenna is to be mounted at the top and at roof level there will be a microwave dish aerial for an STL connection to the broadcasting studios.

The Design Development stage was begun in October 1976 and completed in April 1977. Originally the intention was to start work on site by the end of 1977 but this will not now happen and the timescale is currently unspecified.

DESCRIPTION OF STRUCTURE

Superstructure

The lattices are formed from single precast concrete units which are erected and then joined by in situ reinforced concrete joints. Prestressing ducts will be cast into the units so that subsequently they can be stressed together, a process which will be performed in two stages. The bottom half of each lattice is stressed from the restaurant roof level with dead-end anchorages at the lower ends; the top halves are stressed from the tops of each line of elements with dead-end anchorages at roof level.

The restaurant floor and roof slabs are 300 mm thick and supported vertically by the central core, by the lattices and by two steel trusses which span between the lattices (Fig. 4). The trusses act compositely with the concrete slabs which provide horizontal restraint to the top and bottom chords. The trusses also support the mezzanine restaurant slabs which in turn provide lateral restraint to the truss bracing members. The restaurant floor and roof slabs contain prestressing cables to provide tie forces both across the face of each lattice and between the two lattices.

At transfer level the central core changes to a section circular in plan with cross-walls cantilevering out. The transfer and plantroom roof slabs cantilever out from this circular core. Above the plant room roof the central core reduces in size and continues up to the observation roof level.

At the base, the lattices are supported on reinforced concrete walls which are hollow with vertical cross-walls on the lines defined by the intersection of the lattice members above.

Foundations

The tower will be located on a reef roughly 450 m out from the shore. The sea bed is about 1 m below mean sea level and consists of coral growth and shelly sand on top of 1-2 m of sandstone cap-rock overlying limestone. The proposed foundations consist of a 2 m thick pilecap supported on 250 steel pipe piles of 500 mm diameter. The piles will be driven through the cap-rock into the limestone and then filled with concrete.

A specification has been prepared for a site investigation which will be carried out at the start of the next stage of the design. The foundation design is therefore only preliminary at this stage.

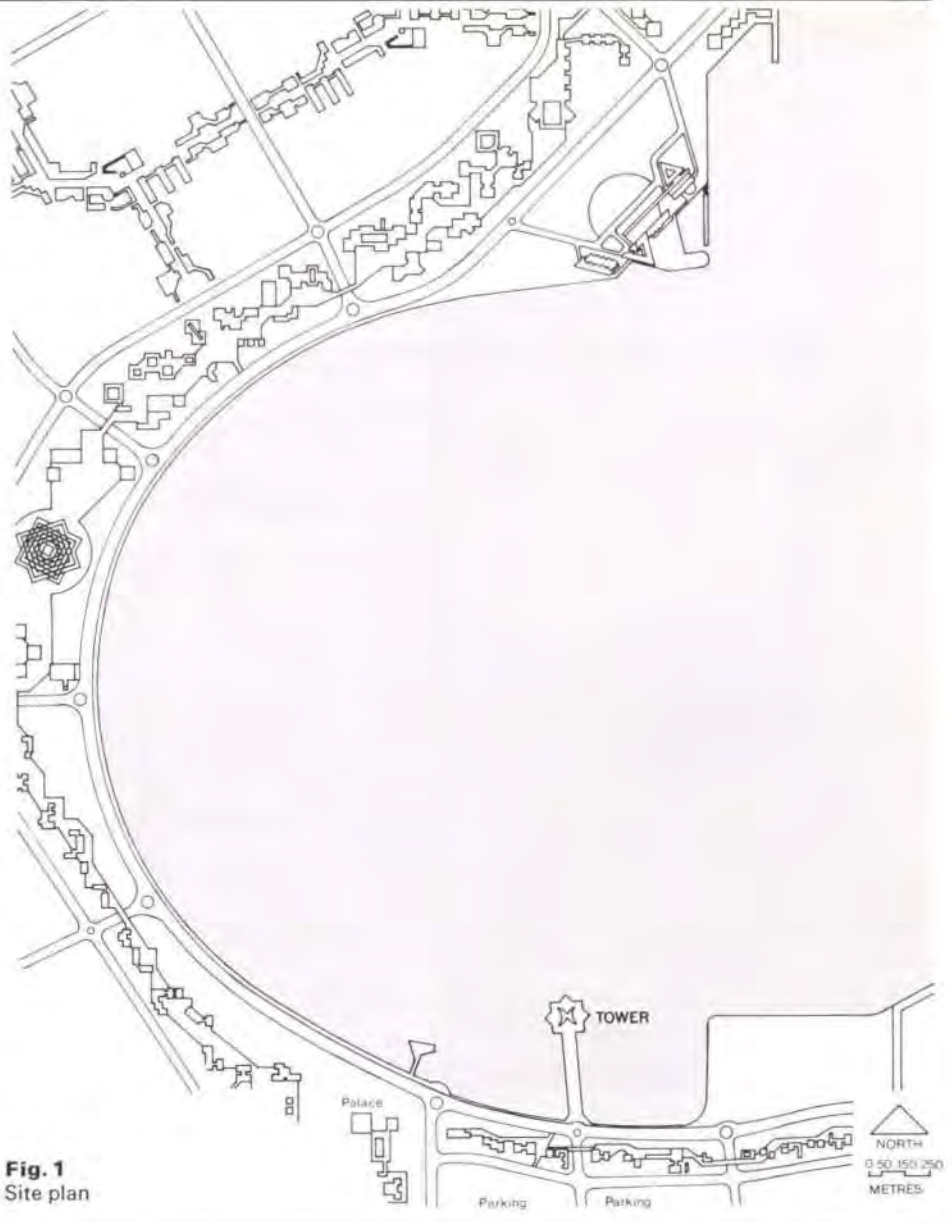

Fig. 1
Site plan

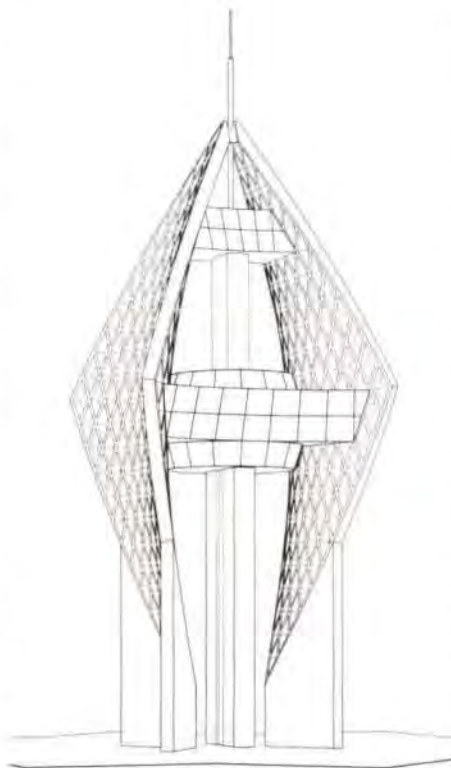

Fig. 2
Perspective view

DEVELOPMENT OF THE DESIGN

Preliminary structural analysis

The first step was to carry out a structural analysis. This was essential for a number of reasons as follows:

- (i) To establish the qualitative structural behaviour of the system when subjected to vertical and horizontal loading
- (ii) To study the interaction between the lattice shells and the restaurant and observation floors. This was necessary in order to decide whether to combine these structurally or to isolate them.
- (iii) To check that the sizes of the members proposed by the architect were structurally feasible.

The structure was analyzed as a three-dimensional frame using the PAFEC system. Special computer graphics routines were written so that the forces and bending moments could be plotted and the results more easily assimilated (Fig. 5).

This analysis showed that at least one floor at mid-height was needed to act as a tie both across the middle of each lattice and also between the two lattices. Without this tie action the deflections under dead load would be unacceptably large.

With this tie action operating, the forces and bending moments induced appeared acceptable. Although some members at the junction with the support walls were relatively highly stressed, it was considered that this would be resolved when the loading had been more

accurately assessed and the modelling of the support walls improved.

It was therefore decided that the scheme was structurally viable, at least in principle.

Geotechnical considerations

The brief from the architect was that the tower should be positioned on an axis defined on the master town plan. However, within this limitation, the position was largely determined by the geology of the sea-bed.

The existing data consisted of some borehole results, sea-bed contours and aerial photographs and this information was analyzed in the context of the background geology of Doha.

Two alternative hypotheses were put forward to explain the known facts and it was recommended that a site investigation be carried out to establish which was correct. The more likely hypothesis indicated that of the various possible alternative locations, the most suitable position was centrally on the reef, approximately 450 m from the shore, and it was therefore decided to put the tower in this position.

Development of the geometry

The original scheme presented to the client by the architect in June 1976 was based on a hyperbolic paraboloid geometry.

It was, however, apparent from the preliminary analysis that the structure would behave as a three-dimensional frame and that there was no intrinsic structural advantage in the hyperbolic paraboloid surface in this case.

It appeared that a construction method involving precasting units on the ground and erecting them would be the best and most economical. It was therefore decided to explore alternative geometries, within the overall aesthetic concept, so as to optimize the design with regard to the precasting of all the elements.

The solution adopted was a toroidal surface with the member centrelines arranged so as to intersect at constant angles throughout the lattice (Fig. 6). (A toroid is the surface generated by one circle moving around another.) The advantage of this solution is that the node junctions will be identical, although the members will vary in length. (It was, in fact, found to be geometrically impossible to achieve exactly constant angles, although the variation in the final scheme is small enough to be ignored for practical purposes.) The diamonds formed by the lattice are smallest at the centreline and largest at the outside but all are effectively of the same proportions.

Each element is prismatic (i.e. the corner edges are all parallel to the theoretical centreline geometry) and the cross-section of each element is defined by a 2 m × 0.6 m rectangle.

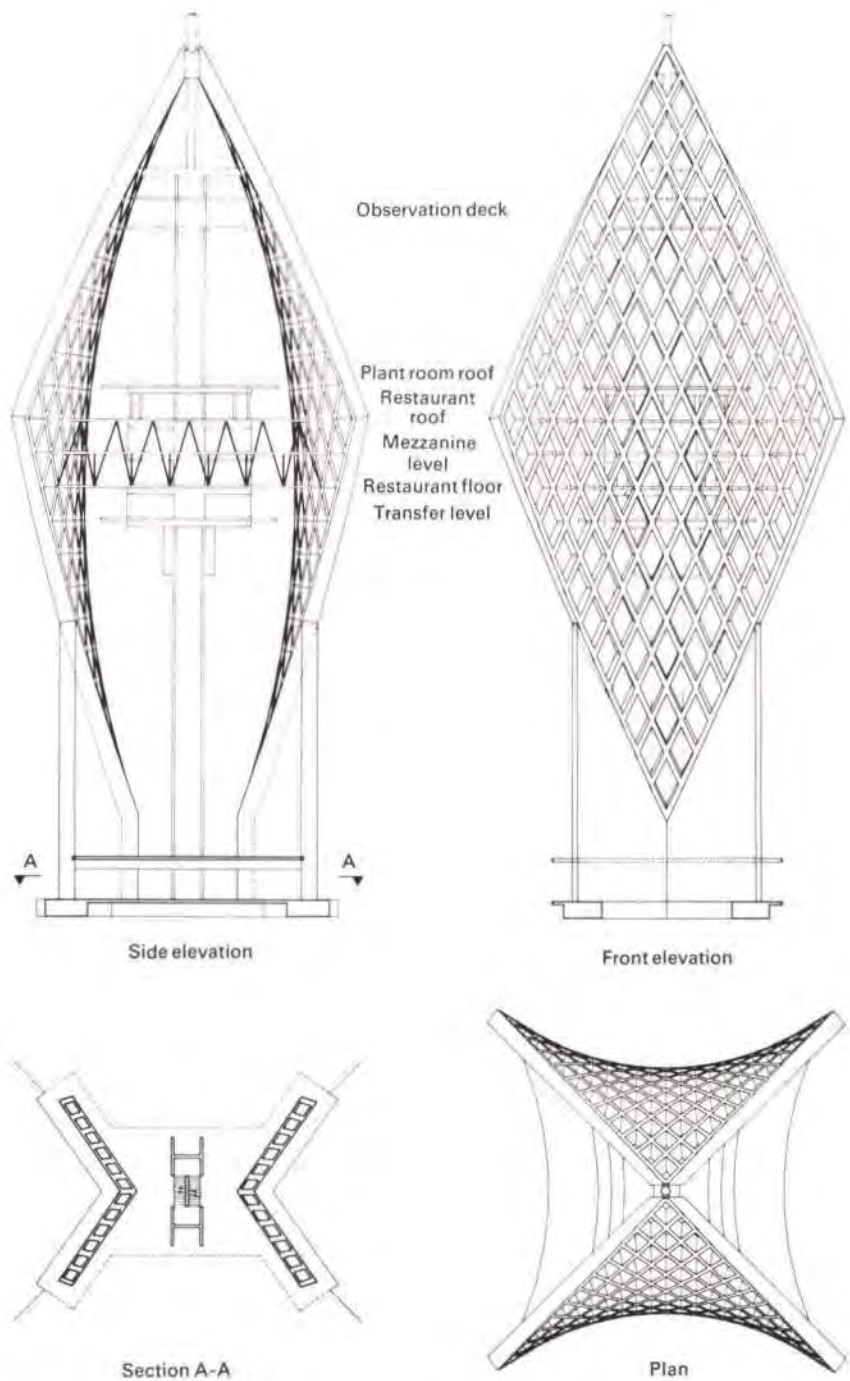

Fig. 3
Plan and elevations

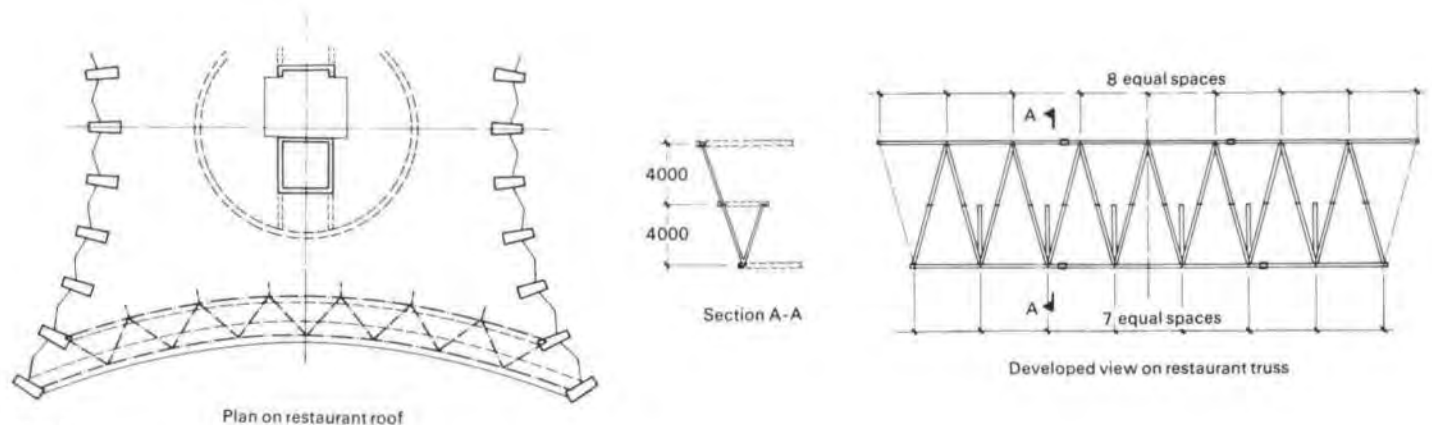

Fig. 4
Restaurant structure

This definition has the advantage of producing elements with plane sides but results in discontinuities at the nodes. These discontinuities, however, can be taken up in the in situ joints.

Extensive use was made of the computer in this development. The technique used was to program the geometrical definition and to adjust the governing parameters until a satisfactory shape was obtained. The geometric data was then stored in the computer and later accessed for the production of drawings and for the structural analysis (Fig. 7).

Initially the geometry was based on the same proportions as the original scheme but subsequently, as a result of discussions between architect and client, it was decided to reduce the overall width, resulting in a more slender appearance, and the geometry was re-calculated.

Restaurant and observation areas

Once the geometry of the toroid lattices had been established, the next stage was the design of the restaurant and observation floors. Horizontal sections through the lattices were prepared so that the architect could plan these areas.

In the end, the final shape of the restaurant was largely determined by the structural system proposed, which involved supporting the free edges on each side on steel trusses spanning between the lattices. This system has the advantage of reducing the thickness of the floors required without introducing internal columns, and avoids the need for a bulky supporting structure either above or below.

Alternative construction methods

From the outset it was recognized that the construction method would significantly affect the design of the structure. Particularly critical was the choice of precast unit and the following alternatives were considered possible:

- (i) Single element units
- (ii) Inverted vee units
- (iii) Cruciform units
- (iv) Split diamond units.

Alternatives (ii)–(iv) would, very roughly, be twice as heavy as (i) but, on the other hand, would be effectively self-supporting when erected. There was, therefore, a choice between saving on cranes or reducing the amount of temporary falsework.

Other fundamental considerations were the method of making the in situ joints and the choice between reinforced and prestressed construction and, if prestressed, which system to use.

The number of possible permutations of these alternatives was large indeed and it became clear that the optimum design would not be achieved without the participation of a construction firm. It was therefore recommended that the design be developed in conjunction with a single contractor, so that the cost implications of the different alternatives could be examined and the most economic selected.

The client, however, was not able to agree to this proposal and therefore a number of international contractors were approached and asked whether they would be interested in participating in the design development and later on being included in a list of tenderers.

As a result, two contractors were interested in contributing to the design development of the project. However, with the decision by the client not to proceed immediately with the site investigation and the wind tunnel tests, it was apparent that the project would not proceed as soon as had been thought, and it was considered that it would be unreasonable to expect contractors to invest significant effort and expense without remuneration on a project that now had an unspecified timescale.

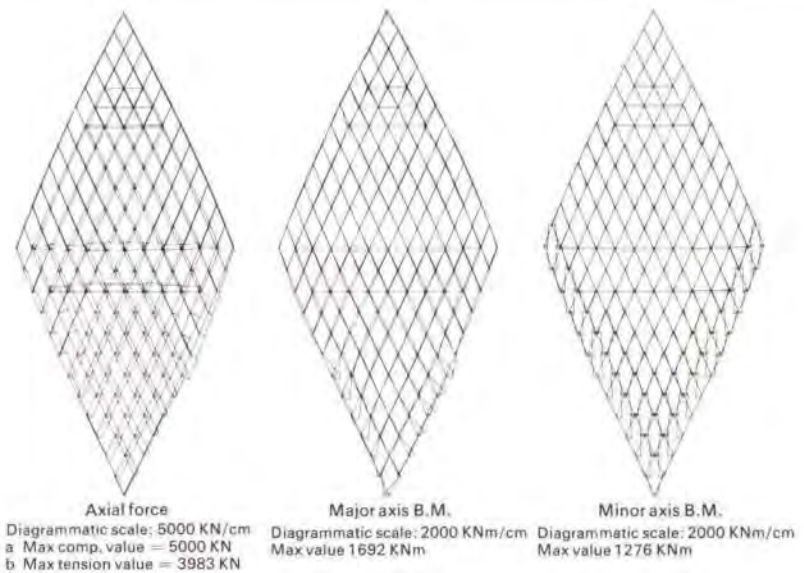

Fig. 5 Bending moment diagrams

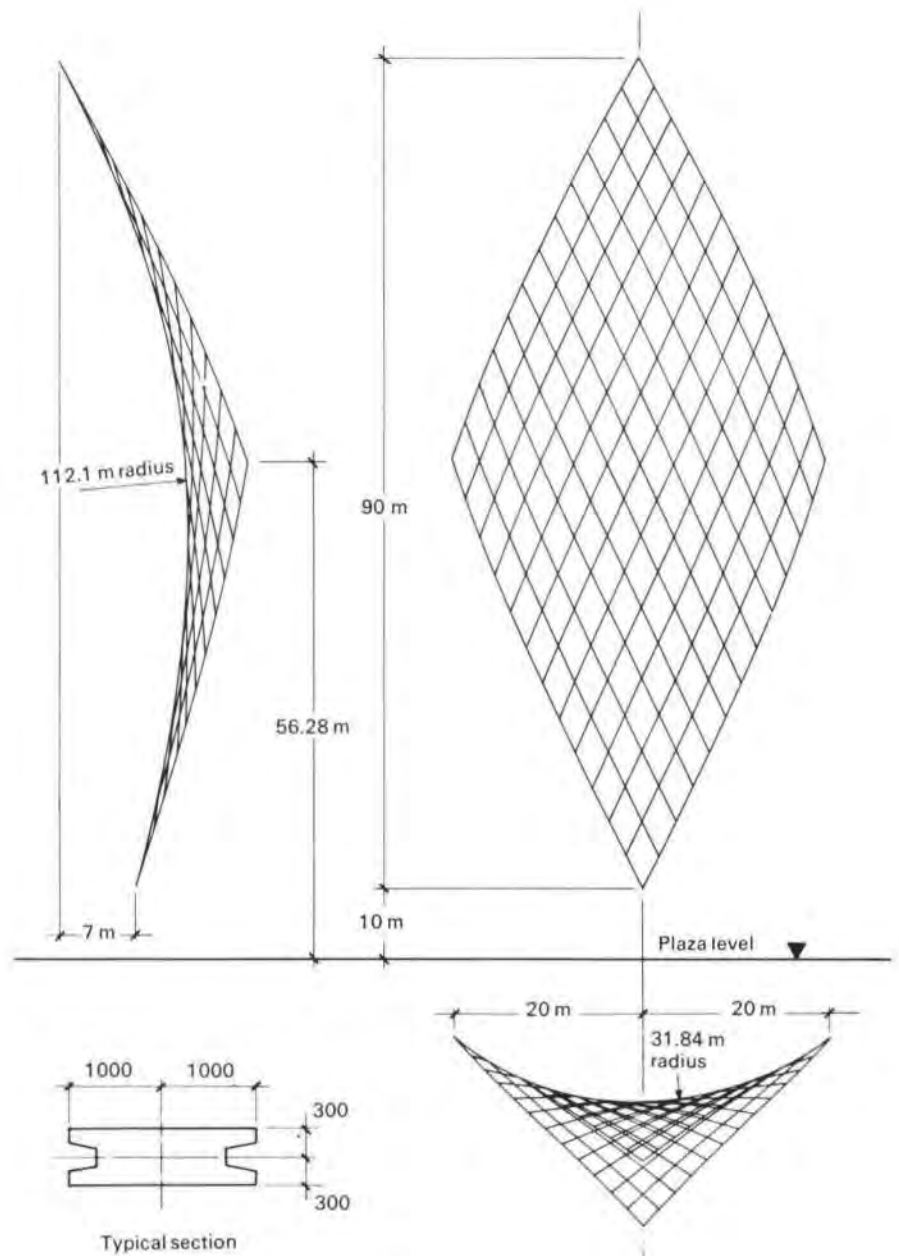

Fig. 6 Geometry

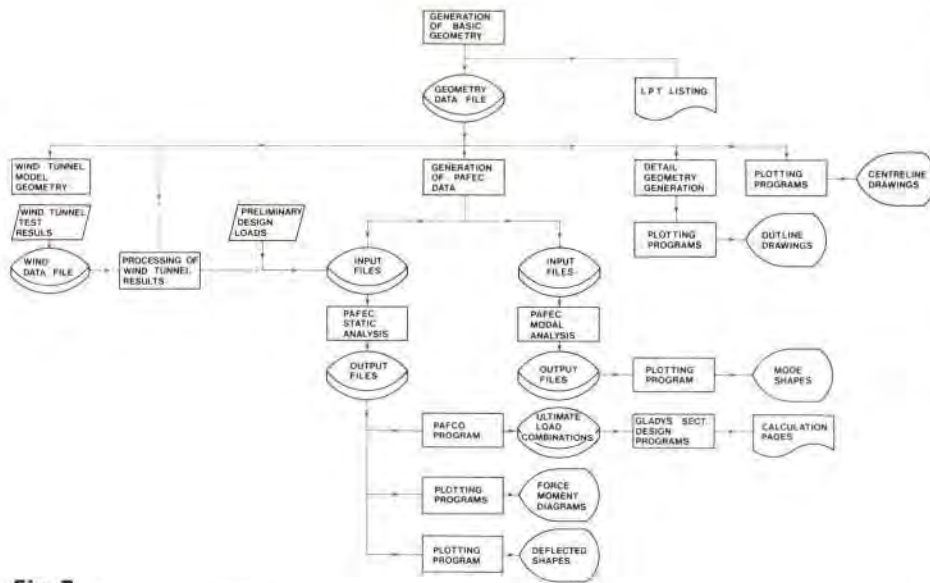

Fig. 7
Computer design flow chart

In order to obtain realistic cost and time estimates for the project it was therefore necessary to develop one construction method in some detail. The method chosen is shown in Fig. 8 and involves precasting single members on the ground and erecting them with the aid of special jigs providing support both for the members and for access platforms. The jigs would be adjustable to allow accurate setting out, and would hold the members until the in situ node joints were cast. This method would eliminate the need for temporary falsework. When the construction method is finalized it will be necessary to check the structure for the temporary construction conditions as part of the final design.

Wind analysis

The available wind data for Doha was analyzed and design wind speeds for a 100 year return period were determined. For the preliminary design, approximate wind loads for the front and side wind directions were calculated using a number of alternative methods which all showed reasonable agreement. In view of the unusual shape of the tower a wind tunnel test was considered to be essen-

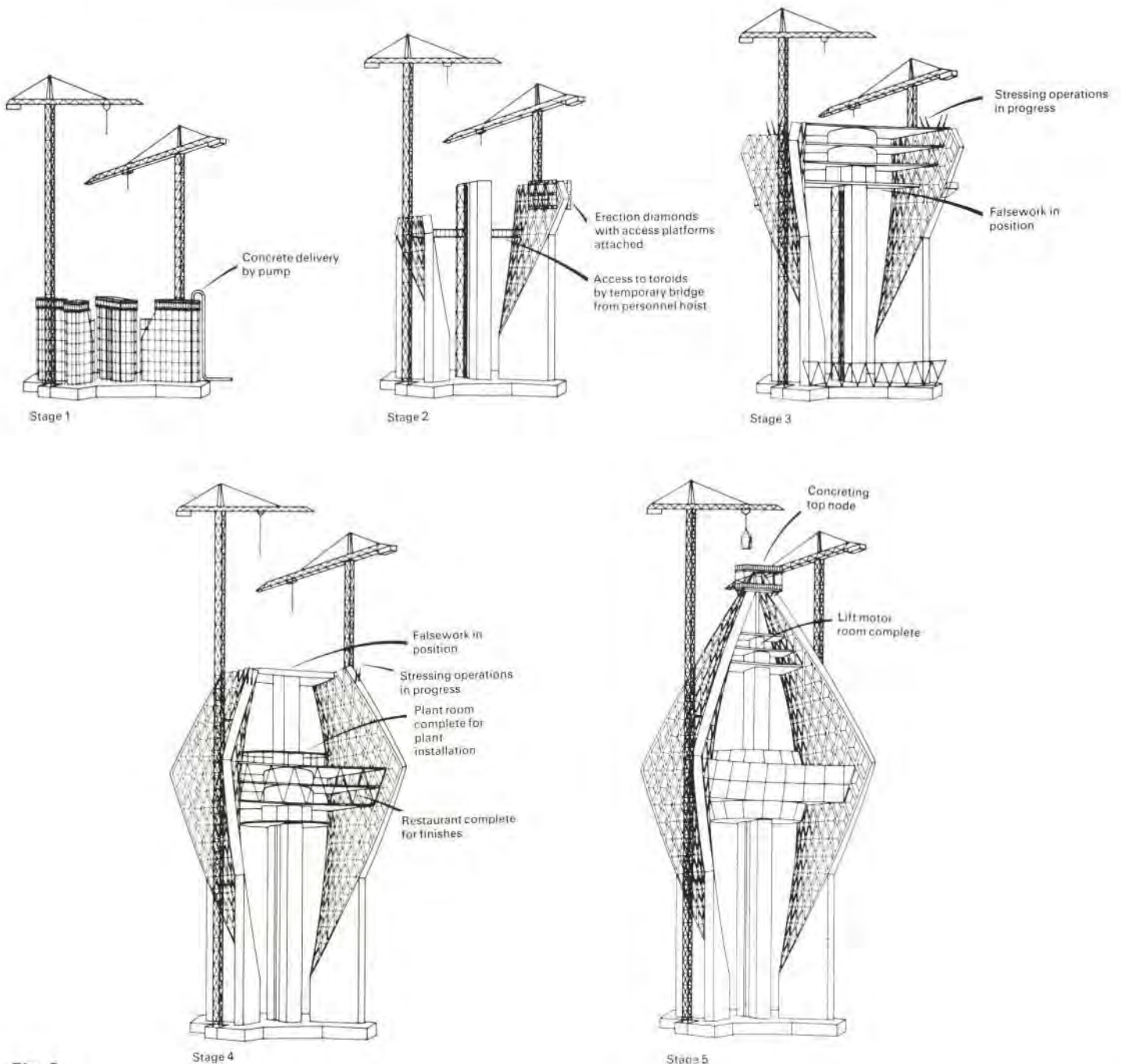

Fig. 8
Construction sequence

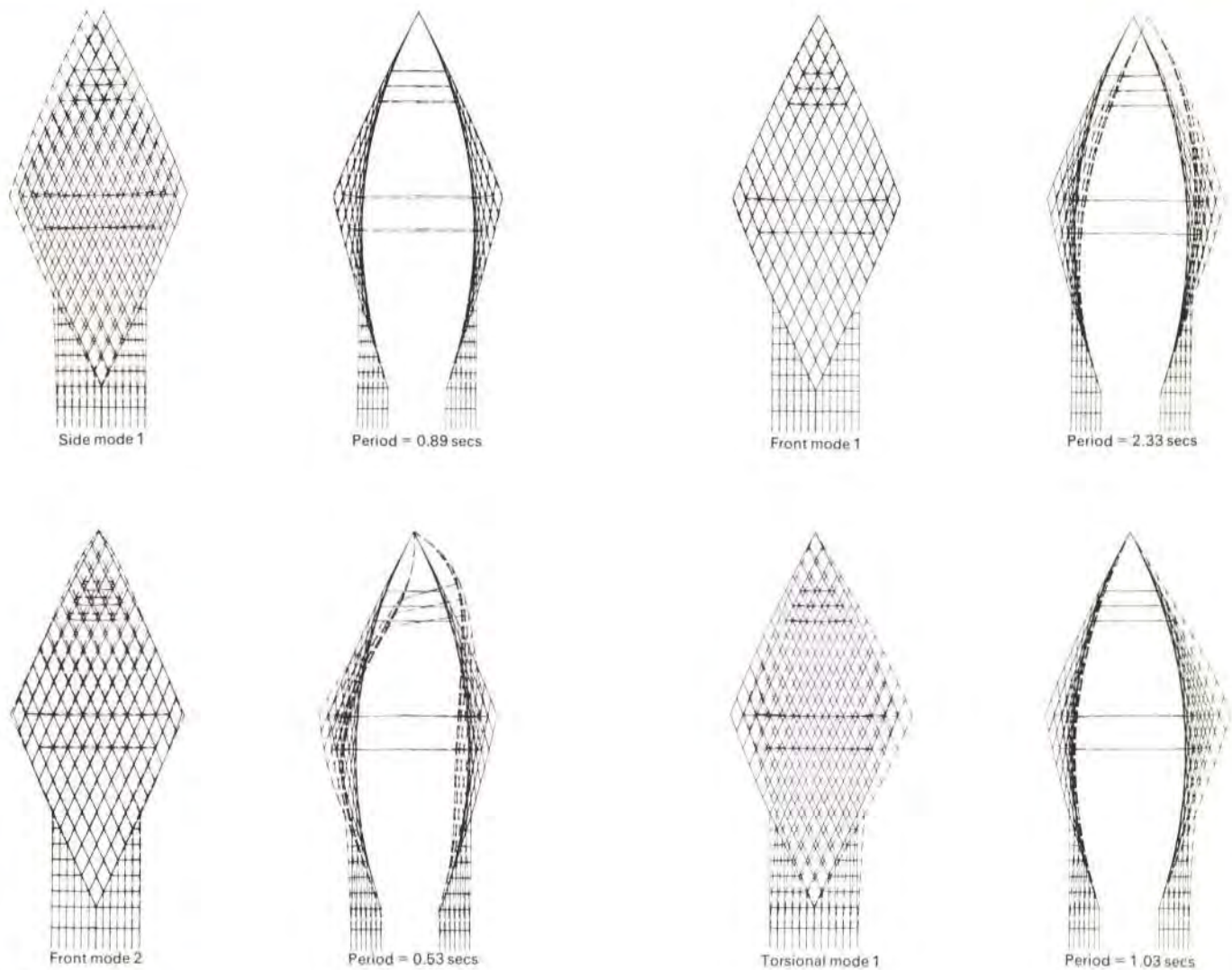

Fig. 9
Mode shapes

tial in order to establish reliable wind load information. A specification for the structural wind tunnel tests was prepared and the procedure for analyzing and utilizing the results was established.



Fig. 10
Photograph of architect's model (Photo: courtesy of William L. Pereira Associates)

It was hoped that the tests could be performed in sufficient time to allow the incorporation of the results in the second structural analysis. However, in the event the client decided not to proceed immediately with the tests and the wind loads were again determined theoretically. In view of the uncertainties in the calculated figures the loads used in the actual analysis were rounded up and rationalized and it is felt that the results should be on the conservative side.

Second static analysis

Once the layout of the cores and restaurant floors had been finalized a more accurate estimate was made of the loading; three loading conditions were considered, vertical load, side wind and front wind. The analytical model used was more sophisticated than that used in the preliminary analysis. The observation level floors and the restaurant floor and roof were taken into account, and the support walls were more accurately modelled. The restaurant truss was found to contribute significantly to the stiffness in the front direction and was included in the model for front wind loading. Only half of one lattice was modelled, the structure being cut on the two vertical planes of symmetry. Symmetric and anti-symmetric boundary constraints were applied as appropriate to each loading condition. Using the routines already developed for accessing PAFEC results, a general purpose program PAFCO was written to combine the results of different PAFEC analyses.

Each member was checked for ultimate load conditions in accordance with CP110. Eight ultimate load combinations were generated

from the three original loadcases using the PAFCO program. These load combinations were input directly into the GLADYS Irregular Column Program to check the sections (reinforced and prestressed) for axial load and biaxial bending in accordance with CP110.

Dynamic analysis

A modal analysis was carried out in order to assess the likelihood of wind excitation causing dynamic loading effects.

A PAFEC analysis was performed using the same model as that for the second static analysis. A total of four runs, each with a different combination of symmetric and anti-symmetric boundary constraints, was required to obtain all the critical modes (Fig. 9).

Programme and cost estimate

A construction programme was produced based on the construction method described above, and the quantities of materials, plant and manpower required were estimated. These figures were passed on to the quantity surveyor, who produced a cost estimate for the project based on local rates in Doha. The total estimated cost at May 1977 rates came to £19m. with a construction period of three years.

Credits

Client

His Highness Sheikh Khalifa bin Hamad al Thani, Amir of the State of Qatar

Architect:

William L. Pereira Associates

Quantity surveyor:

Widnell and Trollope

Computer controlled environments

Robert Aish

The Computer Group is concerned with exploiting the effective use of computers in the design of the built environment. However, as hardware costs fall and energy costs rise it may become increasingly cost-effective to not only use computers in the design process, but also in the control of the internal building environment. Using suitable transducers the computer can monitor the external environment, the internal environment of the building and the performance of the building services. Given a suitable control strategy the computer can employ far more complex conditional checks to control the building services than can be achieved using conventional mechanistic controllers. This strategy, in the form of software, is far more easily modified than the hardwired interconnectors used with existing controllers (Fig. 1). For example, a Cyber 17 computer is being used at the Centre Pompidou to monitor the performance of existing control systems and will later be used in a more active role in the control process (Fig. 2). In this context the design of the control strategy for the building services (let us call it the programme of control) can be considered to be as much a part of the overall design of the building as the selection and sizing of the building services and plant.

However, in considering any new system, it is always worth identifying any major problem and then immediately proposing a solution that can not only solve that problem but also offer additional advantages. So, while there may be potential advantages in using mini-computers and microprocessors in the environmental control process, the building services engineer may be rather discouraged if the only way he can write his programme of control is in the machine code for the particular equipment he has selected.

A 'high-level' building control language

We believe that this problem could be overcome if the building services designer was offered a special high level language in which to write this programme of control. Such a programme of control written in a high level language can be given two different processings (Fig. 3). First, it can be compiled into the machine code used by the process control computer or microprocessor installed in the building. Second, this programme of control can be used as input into a building simulation program (such as the one which the firm has developed) so that the building services

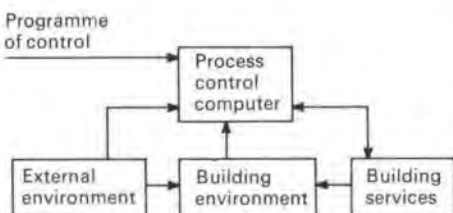

Fig. 1

A process control computer can be used to monitor the external environment and the building environment. Given a suitable programme of control it can optimize the control of the building services using more sophisticated conditional checks than can be achieved with mechanistic controller.



Fig. 2

The Cyber 17 computer installed in the Centre Pompidou, Paris. This system has been designed to monitor and control the Centre's services including power supplies, air conditioning and security systems. Later the Cyber 17 computer will be used to optimize the running of these services on the basis of data collected in the monitoring process. (Photo: Systems International)

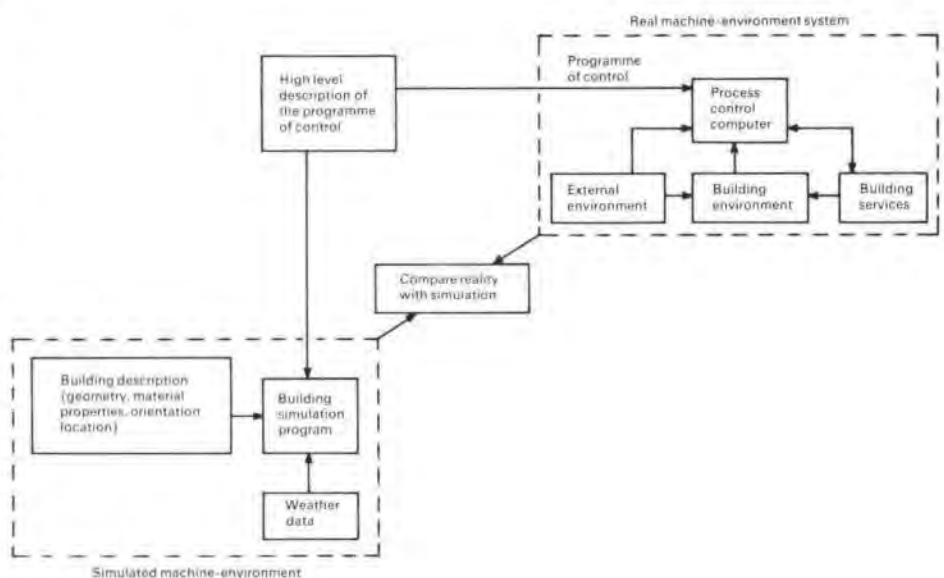

Fig. 3

A high level language enables the building services designer to specify easily the programme of control. This programme can be used with the process control computer in the real machine-environment system and to control the building simulation program. Using the simulated machine environment system allows the building services designer to develop and test different building control strategies before the building is complete.

designer can see the effect of his programme of control before becoming committed to particular types of plant or particular control strategies. As a subsidiary point, the use of a computer to control an environment provides an ideal facility to monitor both the environment and the performance of the building services. Such a system could provide useful empirical data with which to 'tune' the building simulation programs.

This high level language would be formed from English and numeric mnemonics and would be designed to follow closely existing conventions and symbols used in the building services design. For example, such a language would allow conditional control statements. It would require the following statement:

'IF the return water temperature is less than the set point value, then reduce the chiller capacity by 20% for each degree difference in temperature' to be written with Fortran-like symbols and syntax as:

IF (RWT .LT. SPV) CC = CC - (CC * (SPV - RWT) * 20/100)

This concept of compiling programs on one

machine for use on another machine is derived from avionics. Such a procedure protects the building services designer from having to learn the idiosyncrasies of the particular machine code used by that computer, or alternatively such a procedure allows the process control computer to be programmed in a high-level language without the need for that computer to be large enough to service compilers and other utility programs.

We are not yet at the stage where we would want to change from one manufacturer to another depending on who was offering the most competitively priced equipment. However, the existence of one high-level language which could be compiled into many different machine codes suitable for different mini-computers or microprocessors would mean that the building services designer would be independent of a specific manufacturer, and would not be inhibited from changing manufacturer.

The role of the human controller

Even with the advent of computer-controlled environments, the building services designer may decide that a human controller should

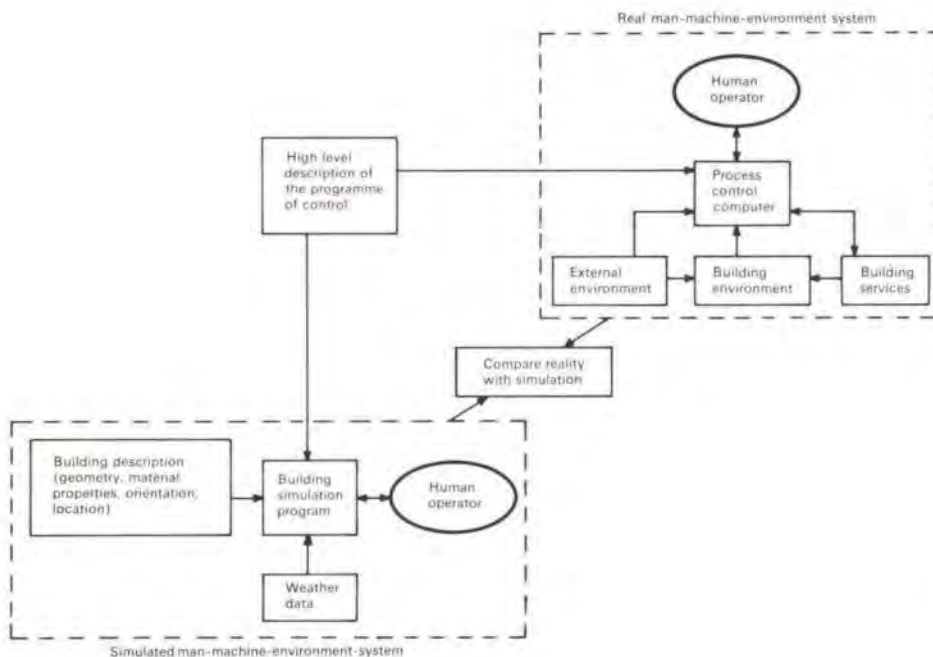

Fig. 4
If a human operator is included in the system then by designing the programme of control the building services designer is effectively designing the job of the human operator. The building simulation program can be run in 'real time' to simulate the control task for the human operator.

continue to have a role, probably an overriding role, in this control process (Fig. 4). In this case, by formulating the programme of control, the building services designer is effectively designing the job of the human operator. Such a job design constitutes a man-machine system within what is now effectively a man-machine-environment system. The details of the operator's role, for example, how and when he can intervene in the operation of the system and the form of the advice which the process control computer may give the operator, should be approached with due consideration for the psychological problems such as habituation which are associated with continuous monitoring and control tasks.

As a further development, if the programme of control does call for the intervention of a human operator then the building simulation program could be run in 'real time' to simulate the control task of the operator. By 'real time' we mean the following. If we have weather data which records weather variables at an interval of, for example, 15 minutes, then we can run the building simulation program in such a way that it only performs one complete set of calculations every 15 minutes. When the program has performed one set of calculations (for every element of every wall of every room of the building, etc.) it is temporarily stopped by the timesharing monitor on the DEC-10. The monitor will restart the program 15 minutes later. Because the

timesharing monitor is servicing other users during the 15 minute interval between calculations this procedure is by no means an expensive use of computer resources. Thus at 15 minute intervals the program displays the new building state information to the operator seated at a terminal and he can then input control information.

If the operator inputs control information that will modify the behaviour of the simulated building services then the timesharing monitor would restart the program at whatever time interval is appropriate to model the continuous behaviour of the building and the services, and display the appropriate information to the operator.

With such a system the operator learns to control the building services system in the context of the real time delays associated with the response of the building and the building services. Such a facility enables the building services designer to compare alternative programmes of control which give different roles to the human operator and he can also compare alternative styles of intervention used by different human operators. By monitoring the way the operator deals with the simulated control task, the building services designer will be provided with an insight into the way the operator uses the information which is presented to him and with an insight into the types of strategies which the operator employs under unusual or emergency conditions.

In addition, a situation can now be envisaged where a client who wishes to introduce computer-controlled building services could ask us to train an operator for these services, using this computer simulated control task.

Man-machine interaction

The man-machine interaction could be through an inexpensive colour semi-graphic terminal which can display graphical presentation of dials, histograms and state diagrams. This display can be considered as a 'programmable window' on a hypothetical console which would normally consist of electro-mechanical components, such as dials and switches. A semi-graphic display does not offer the same 'full' graphics facilities such as found on our Tektronix terminals, but its facilities to display text and draw a limited number of vectors is quite sufficient for this kind of process control application. What is more important is that such displays are 'refreshable' whereas a Tektronix uses the storage tube principle. With a refreshable display the picture is being refreshed 20-40 times a second. This means that because the redraw procedure is so fast and so frequent the impression can be given to the operator that parts of the picture are changing while the rest of the picture is held steady. This is extremely useful when we wish to display dynamically changing information.

Colour coding can also be used; for example, temperature could be indicated on a blue to red continuum, or different parts or states of the building services could be identified on a colour coded state diagram.

Techniques already exist to analyze the way the operator uses such control information so that graphic representation of the display components can be given a convenient spatial arrangement on the display screen. The advantage of a graphic display terminal is that any one display component can be grouped with other display components in different display pictures which might relate to different moments of the control task. Compare this with the traditional physical control console where only one static arrangement of display components is possible.

Control input from the operator to the system could be through either a command language which uses a conventional alphanumeric keyboard, by using a special function keyboard or by using a menu system displayed on the screen, or any combination of these.

Conclusion

This technology and systems design is already in use in some process industries where, because of the accuracy required in the control of the process and the cost 'down-time', computer control can be shown to be cost-effective.

As the cost of these systems fall so they become potentially cost-effective in other process control applications. To anticipate this development, we have begun to prototype part of the system I have outlined.

Acknowledgment

I would like to acknowledge John Campbell as the author of the building simulation program.

Structural Steel Design Award 1977

Arup Associates have won the above award in the 'Building' category for Bush Lane House (Job No. AA219) which is illustrated below



